

MIG Series

MIG 500P Separate (JM-500P)

Operator Manual



Intertek

CE

UK
CA



Your new product

Thank you for selecting this Jasic product.

This product manual has been designed to ensure that you get the most from your new product. Please ensure that you are fully conversant with the information provided paying particular attention to the safety precautions. The information will help protect yourself and others against the potential hazards that you may come across.

Please ensure that you carry out daily and periodic maintenance checks to ensure years of reliable and trouble free operation.

Please call your Jasic distributor in the unlikely event of a problem occurring.

Please record below the details from your product as these will be required for warranty purposes and to ensure you get the correct information should you require assistance or spare parts.

Date purchased _____

From where _____

Serial number _____

(The serial number is normally located on the top or underside of the machine (Power source) and will begin with AA)

For further information on your Jasic product warranty registration please visit:

www.jasic-warranty.co.uk

Disclaimer

Whilst every effort has been made to ensure that the information contained within this manual is complete and accurate, no liability can be accepted for any errors or omissions.

Please note:

Products are subject to continual development and may be subject to change without notice.

Regularly check our product pages at www.Jasic.co.uk for revision updated operating manuals.

No part of this manual may be copied or reproduced by any means without the written permission of Wilkinson Star Limited.

CONTENTS

Index	Page
Your New Product	2
Index	3
Safety Instruction	4
General electrical safety	4
General operating safety	4
PPE	5
Welding processes lens shade selector guide	5
Fume and welding gases	6
Fire risks	6
The working environment	7
Protection from moving parts	7
Magnetic fields	7
Compressed gas cylinders and regulators	7
RF declaration	8
LF declaration	8
Materials and their disposal	8
Product Overview	9
Technical Specifications	10
Panel layouts	11
Installation	13
Control Panel	15
Operating Parameters	22
Operation MMA	26
Guide to MMA Welding	27
MMA Welding Problems	31
Operation MIG/MAG	32
Guide to MIG/MAG Welding	44
MIG Welding Chart	51
MIG Welding Problems	52
MIG Water Cooled Welding Torch	54
Maintenance	56
Service Schedule Record	56
Troubleshooting	57
Error codes	59
Submenu	60
WEEE Disposal	61
RoHS Compliance Declaration	61
UKCA Declaration of Conformity	61
EC Declaration of Conformity	62
Statement of Warranty	63
Wiring diagrams	64
Options and Accessories	65
Notes	66
Jasic Contact Details	68

SAFETY INSTRUCTION

These general safety norms cover both arc welding machines and plasma cutting machines unless otherwise noted.

It is important that users of this equipment protect yourselves and others from harm or even death. The equipment must only be used for the purpose it was designed for. Using it in any other way could result in damage or injury and in breach of the safety rules.

Only suitably trained and competent persons should use the equipment.

Pacemaker wearers should consult your doctor prior to using this equipment.

PPE and workplace safety equipment must be compatible for the application of work involved.

Always carry out a risk assessment before undertaking any welding or cutting activity

General electrical safety



The equipment should be installed by a qualified person and in accordance with current standards in accordance with current standards in operation. It is the users responsibility to ensure that the equipment is connected to a suitable power supply. Consult with your utility supplier if required. Do not use the equipment with the covers removed.

Do not touch live electrical parts or parts which are electrically charged.

Turn off all equipment when not in use.

In the case of abnormal behaviour of the equipment, the equipment should be checked by a suitably qualified service engineer.

If earth bonding of the work piece is required, bond it directly with a separate cable with a current carrying capacity capable of carrying the maximum capacity of the machine current.

Cables (both primary supply and welding) should be regularly checked for damage and overheating.

Never use worn, damaged, under sized or poorly jointed cables.

Insulate yourself from work and earth using dry insulating mats or covers big enough to prevent any physical contact.

Never touch the electrode if you are in contact with the work piece return.

Do not wrap cables over your body.

Ensure that you take additional safety precautions when you are welding in electrically hazardous conditions such as damp environments, wearing wet clothing and metal structures.

Try to avoid welding in cramped or restricted positions.

Ensure that the equipment is well maintained. Repair or replace damaged or defective parts immediately.

Carry out any regular maintenance in accordance with the manufacturers instructions.

The EMC classification of this product is class A in accordance with electromagnetic compatibility standards CISPR 11 and IEC 60974-10 and therefore the product is designed to be used in industrial environment only.

WARNING: This class A equipment is not intended for use in residential locations where the electrical power is provided by a public low-voltage supply system. In those locations it may be difficult to ensure the electromagnetic compatibility due to conducted and radiated disturbances.

General operating safety

Never carry the equipment or suspend it by the carrying strap or handles during welding.

Never pull or lift the machine by the welding torch or other cables. Always use the correct lift points or handles. Always use the transport under gear as recommended by the manufacturer.

Never lift a machine with the gas cylinder mounted on it.

If the operating environment is classified as dangerous, only use S-marked welding equipment with a safe idle voltage level. Such environments may be for example: humid, hot or restricted accessibility spaces.

SAFETY INSTRUCTION

Use of Personal Protective Equipment (PPE)

Welding arc rays from all welding processes produce intense, visible and invisible (ultraviolet and infrared) rays that can burn eyes and skin.

- Wear an approved welding helmet fitted with an appropriate shade of filter lens to protect your face and eyes when welding or watching.
- Wear approved safety glasses with side shields under your helmet.
- Never use broken or faulty welding helmets.
- Always ensure there are adequate protective screens or barriers to protect others from flash, glare and sparks from the welding area.
- Ensure that there are adequate warnings that welding or cutting is taking place.
- Wear suitable protective flame resistant clothing, gloves and footwear.
- Check and be sure the area is safe and clear of inflammable material before carrying out any welding.

Some welding and cutting operations may produce noise. Wear safety ear protection to protect your hearing if the ambient noise level exceeds the local allowable limit (e.g: 85 dB).



Welding and Cutting Lens Shade Selector Guide

CURRENT	MMA ELECTRODES	MIG LIGHT ALLOYS	MIG HEAVY METALS	MAG	TIG ON ALL METALS	PLASMA CUTTING	PLASMA WELDING	GOUGING ARC/AIR
10	8							
15								
20	9	10	10	10	10			
30								
40	10					11	11	10
60								
80	11	11	11	12	11			
100								
125	12	12	12	13	12		13	11
150								
175	13	13						12
200								
225	14	14	13	14	13	12	14	13
250								
275	15	15	14	15	14			14
300								
350	16	16	15	16	15			15
400								
450	17	17	16	17	16			16
500								

SAFETY INSTRUCTION

Safety against fumes and welding gases



The HSE have identified welders as being an 'at risk' group for occupational diseases arising from exposure to dusts, gases, vapours and welding fumes. The main identified health effects are pneumonia, asthma, chronic obstructive pulmonary disease (COPD), lung and kidney cancer, metal fume fever (MFF) and lung function changes.

During welding and hot cutting 'hot work' operations, fumes are produced which are collectively known as welding fume. Depending upon the type of welding process being performed, the resultant fume generated is a complex and highly variable mixture of gases and particulates.

Regardless of the length of welding being carried out, all welding fume, including mild steel welding requires suitable engineering controls to be in place which is usually Local Exhaust Ventilation (LEV) extraction to reduce the exposure to welding fume indoors and where LEV does not adequately control exposure it should also be enhanced by using suitable respiratory protective equipment (RPE) to assist with protecting against residual fume.

When welding outdoors appropriate RPE should be used.

Prior to undertaking any welding tasks an appropriate risk assessment should be carried out to ensure expected control measures are in place.



An example of personal fume protection

Locate the equipment in a well-ventilated position and keep your head out of the welding fume.

Do not breathe the welding fume.

Ensure the welding zone is well-ventilated and provision should be made for suitable local fume extraction system to be in place.

If ventilation is poor, wear an approved airfed welding helmet or respirator.

Read and understand the Material Safety Data Sheets (MSDS's) and the manufacturer's instructions for metals, consumable, coatings, cleaners and de-greasers.

Do not weld in locations near any de-greasing, cleaning or spraying operations.

Be aware that heat and rays of the arc can react with vapours to form highly toxic and irritating gases.

For further information please refer to the HSE website www.hse.gov.uk for related documentation.

Precautions against fire and explosion



Avoid causing fires due to sparks and hot waste or molten metal.

Ensure that appropriate fire safety devices are available near the welding and cutting area.

Remove all flammable and combustible materials from the welding, cutting and surrounding areas.

Do not weld or cut fuel and lubricant containers, even if empty. These must be carefully cleaned before they can be welded or cut.

Always allow the welded or cut material to cool before touching it or placing it in contact with combustible or flammable material.

Do not work in atmospheres with high concentrations of combustible fumes, flammable gases and dust.

Always check the work area half an hour after cutting to make sure that no fires have begun.

Take care to avoid accidental contact of electrode to metal objects. This could cause arcs, explosion, overheating or fire.



Understand your fire extinguishers

SAFETY INSTRUCTION

The working environment

Ensure the machine is mounted in a safe and stable position allowing for cooling air circulation.

Do not operate equipment in an environment outside the laid down operating parameters.

The welding power source is not suitable for use in rain or snow.

Always store the machine in a clean, dry space.

Ensure the equipment is kept clean from dust build up.

Always use the machine in an upright position.

Protection from moving parts

When the machine is in operation keep away from moving parts such as motors and fans.

Moving parts, such as the fan, may cut fingers and hands and snag garments.

Protections and coverings may be removed for maintenance and controls only by qualified personnel after first disconnecting the power supply cable.

Replace the coverings and protections and close all doors when the intervention is finished and before starting the equipment.

Take care to avoid getting fingers trapped when loading and feeding wire during set up and operation.

When feeding wire be careful to avoid pointing it at other people or towards your body.

Always ensure machine covers and protective devices are in operation.

Risks due to magnetic fields



The magnetic fields created by high currents may affect the operation of pacemakers or electronically controlled medical equipment.

Wearers of vital electronic equipment should consult their physician before beginning any arc welding, cutting, gouging or spot welding operations.

Do not go near welding equipment with any sensitive electronic equipment as the magnetic fields may cause damage.

Keep the torch cable and work return cable as close to each other as possible throughout their length.

This can help minimise your exposure to harmful magnetic fields.

Do not wrap the cables around the body.

Handling of compressed gas cylinders and regulators

Mishandling gas cylinders can lead to rupture and the release of high pressure gas.

Always check the gas cylinder is the correct type for the welding to be carried out.

Always store and use cylinders in an upright and secure position.

All cylinders and pressure regulators used in welding operations should be handled with care.

Never allow the electrode, electrode holder or any other electrically “hot” parts to touch a cylinder.

Keep your head and face away from the cylinder valve outlet when opening the cylinder valve.

Always secure the cylinder safely and never move with regulator and hoses connected.

Use a suitable trolley for moving cylinders.

Regularly check all connections and joints for leaks.

Full and empty cylinders should be stored separately.

Never deface or alter any cylinder

SAFETY INSTRUCTION

RF Declaration

Equipment that complies with directive 2014/30/EU concerning electromagnetic compatibility (EMC) and the technical requirements of EN60974-10 is designed for use in industrial buildings and not those for domestic use where electricity is provided via the low voltage public distribution system.

Difficulties may arise in assuring class A electromagnetic compatibility for systems installed in domestic locations due to conducted and radiated emissions.

In the case of electromagnetic problems, it is the responsibility of the user to resolve the situation.

It may be necessary to shield the equipment and fit suitable filters on the mains supply.

LF Declaration

Consult the data plate on the equipment for the power supply requirements.

Due to the elevated absorbance of the primary current from the power supply network, high power systems affect the quality of power provided by the network. Consequently, connection restrictions or maximum impedance requirements permitted by the network at the public network connection point must be applied to these systems.

In this case, the installer or the user is responsible for ensuring the equipment can be connected, consulting the electricity provider if necessary.

Materials and their disposal

Welding equipment is manufactured with BSI published standards meeting CE requirements materials which do not contain any toxic or poisonous materials dangerous to the operator.

Do not dispose of the equipment with normal waste. The European Directive 2012/19/EU on Waste Electrical and Electronic Equipment states the electrical equipment that has reached its end of life must be collected separately and returned to an environmentally compatible recycling facility for disposal.

For more detailed information please refer to the HSE website www.hse.gov.uk

PRODUCT OVERVIEW

Jasic MIG JM-500P Product Features:

Key Features

- IGBT multi process inverter
- Pulsed MIG, MIG/MAG, TIG and DC MMA
- Synergic or standard operating modes
- DSP digital technology for optimum welding performance
- Smart fan and water control
- Job storage system
- 4 roll wire feed unit
- Suitable for 0.8, 1.0, 1.2 and 1.6mm welding wire
- Easy parameter settings for the operator
- Synergic curves for common materials & wire diameters
- Self diagnostic system
- Encoder feedback control of wire feed system
- Power & status LED's
- Inverter trolley takes full size gas bottle



The new series of Jasic Pulsed MIGS are equipped with powerful IGBT components, digital meters and multi process capabilities offers excellent welding characteristics and rugged, reliable performance.

The series incorporates a brand-new digital control method. The control circuit consists of a high performance ARM processor, which realizes fine control of the welding waveform. The processor has a CAN BUS communication which provides high speed, bi- directional communication between powers source and wire feeder which in turn offers a wide range of potential functions.

The waveform of pulse current varies with wires of different materials, diameter and shielding gas so that it can achieve optimal arc and welding of high efficiency and quality with excellent weld characteristics. Precise procedure control enables stable transition of the whole processing from arc start to end.

This three phase inverter offers synergic curves for common materials and wires which incorporates self-diagnostic protection systems that provides extreme reliability.

TECHNICAL SPECIFICATIONS

Parameter	Unit	Jasic MIG JM-500P
Rated input voltage	V	AC400V±20% 50/60HZ
Rated input power	kVA	28.1
Rated input current I max	A	40.5
Rated input current I eff	A	28.6
Welding current range	A	MIG 30 ~ 500 MMA 30 ~ 500 TIG 30 ~ 500
No-load voltage	V	86
No-load voltage MMA, TIG(VRD)	V	15
Welding voltage MIG	V	10 ~ 49.9
Rated duty cycle (40°C)	%	MIG 500A @ 50% MMA 500A @ 50% TIG 500A @ 50%
Wire feed type	-	4 Roll - Geared
Wire feed speed range	m/min	1 ~ 23
Suitable wire size	mm	1.0, 1.2, 1.6
Efficiency	%	89
Idle State Power	W	< 50
Power factor	cosφ	0.9
Standard	-	EN60974-1
Protection class	IP	IP23S
Insulation class	-	F
Noise	Db	<70
Operating temperature range	°C	-10 ~ +40
Storage temperature range	°C	-25 ~ +55
Overall size L x W x H	mm	1080 X 510 X 1180
Power source size L x W x H	mm	785 X 330 X 440
Wire feed unit size L x W x H	mm	630 X 235 X 420
Weight (water cooled)	Kg	129

Please Note

Due to variations in manufactured products all claimed performance ratings, capacities, measurements, dimensions and weights quoted are approximate only. Achievable performance and ratings when in use can depend upon correct installation, applications and use along with regular maintenance and service.

PANEL LAYOUT

Front view Jasic MIG JM-500P Power Source and cooler

1. Digital display: Ammeter
2. Selector button: Selection of Amps, wire feed speed, material thickness and time
3. Rotary encoders: Used in adjusting selected parameters and noted on displays 1 and 20.
4. Parameter selector button. Pressing this button moves the selector to light the LED of the parameter to be adjusted
5. Welding mode selector button: Used to select MIG, MIG Pulse, MMA or Lift TIG
6. Material and gas type selector buttons which will allow the user to select required material/gas type
7. "+" Output terminal: To connect the MMA electrode holder (there is also another + socket located on the rear panel)
8. Coolant filler
9. Coolant draining plug
10. Cooler power LED
11. Cooler control fuse
- 12 Control cable socket: Front WFU control socket for connecting the wire feed unit (there is also one located on the rear panel)
- 13 "-" Output terminal: To connect the work clamp
- 14 Wire diameter selection button to select 0.8 ~ 1.6mm sizes
- 15 Torch trigger selector button: spot, 2T, 4T and special
- 16 Gas purge and wire inch buttons
- 17 Synergic ON/OFF button
- 18 Synergic LED
- 19 Selector button: Selection of voltage, arc force (Inductance in MIG mode and arc force in MMA mode) and job save/recall option
- 20 Digital display: Voltmeter

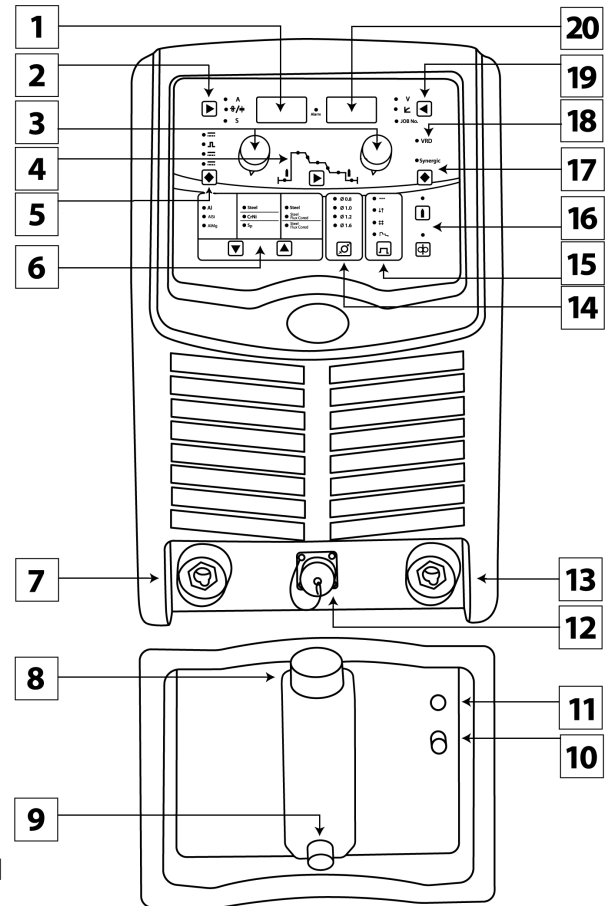

Rear view Jasic MIG JM-500P

1. Mains ON/OFF switch
2. Software interface socket
3. Wire feeder unit socket
4. "+" Output terminal: To connect to the wire feed unit
5. Mains power cable
6. Water cooler supply socket
7. Rear panel cooling air intake
8. N/A

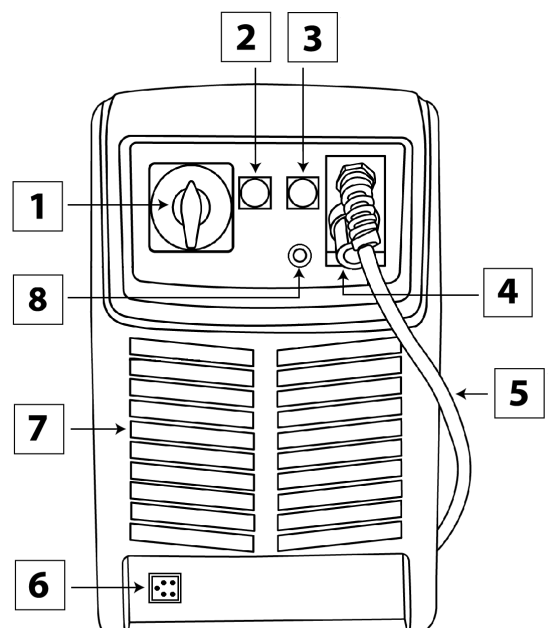

PANEL LAYOUTS

Jasic MIG JM-500P wire feed unit

Front view

21. Digital display
22. Wire speed control dial
23. Wire inch button
24. Euro style MIG torch connector
25. Digital display
26. Lock control button
27. Voltage control dial and Voltage trim in synergic mode
28. MIG torch coolant connection (Red - coolant return)
29. MIG torch coolant connection (Blue - coolant supply)

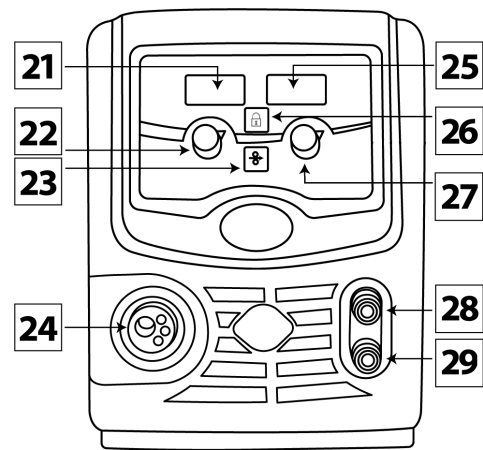

Side view

1. Shield gas connection
2. MIG torch holder
3. Control cable from power source
4. Coolant connection (Red - coolant return)
5. Coolant connection (Blue - coolant supply)
6. '+' Welding cable connection *
7. Welding wire spool cover
8. Interconnection cable

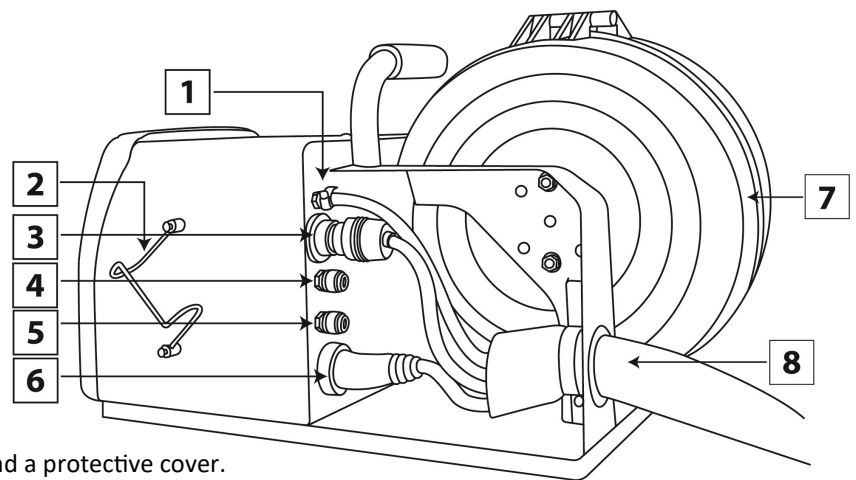

Please Note: Items 1, 3, 4, 5 & 6 are located behind a protective cover.

Side view

9. Wire spool holder and tensioner: Located inside the spool cover is the spool holder that allows a 15Kg (300mm dia) reel of wire to be located in place via an alignment pin and then locked in position with a locking nut. The spool holder also has a brake arrangement to ensure correct tension of the wire, this is done by turning the central bolt with a key either clockwise (to tighten) or anti clockwise (to loosen)
10. Inlet wire guide: The welding wire is fed through the inlet guide prior to feeding through the drive rollers
11. 4 Roll drive wire feed assembly
12. Wire feed roller and retaining nut: Secures and holds the grooved drive roller in place
13. Outlet feed adaptor: Part of the Euro outlet connector which contains the inner outlet guide which ensures smooth wire feed from the drive assembly through to the MIG torch
14. Drive roll tensioner: Allows the correct amount of tension to be applied to the top roller to ensure good feed of the wire through the MIG torch
15. Pressure roll assembly: Holds the upper drive roll in place which applies pressure to the welding wire onto the grooved drive roller
16. Wire feed motor and gearbox

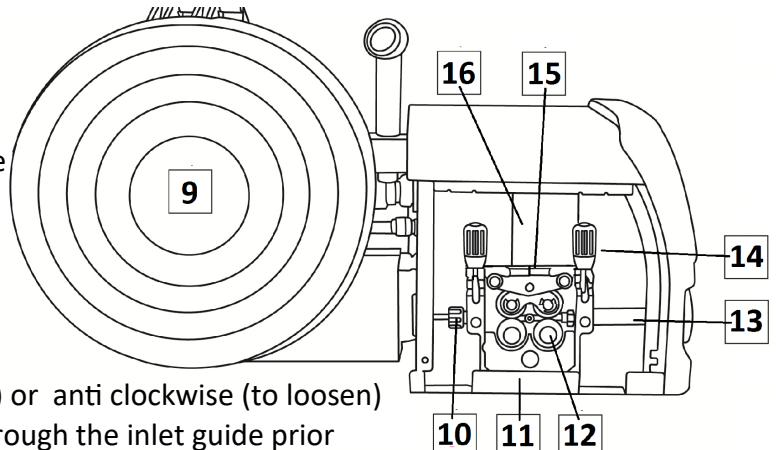

* On the latest Wire Feed Units, the welding cable connects to the feed unit via a welding lug, where as older feed units (as shown above) used a Dinse plug/socket arrangement.

Installation

Unpacking

Check the packaging for any signs of damage.

Carefully remove the machine and retain the packaging until the installation is complete.

Location

The machine should be located in a suitable position and environment. Care should be taken to avoid moisture, dust, steam, oil or corrosive gases. Place on a secure level surface and ensure that there is adequate clearance around the machine to ensure natural airflow.

Input connection

Before connecting the machine you should ensure that the correct supply is available. Details of the machine requirements can be found on the data plate of the machine or in the technical specifications table found on page 10 within this manual.

The equipment should be connected by a suitably qualified competent person. Always ensure the equipment has a proper grounding.

Never connect the machine to the mains supply with the panels removed.

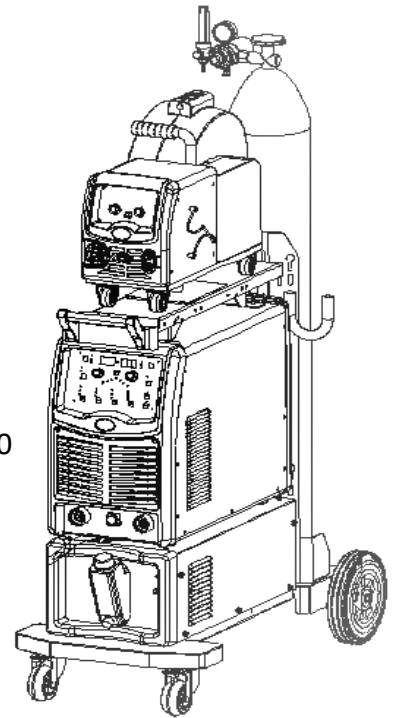

Gas selection

Metal active gas welding (MAG): Uses Argon (Ar) mixed with a certain amount of CO²/O² as the shield gas and it is usually used in short circuit transfer and spray transfer. It can be applicable to flat position welding, vertical position welding, overhead position welding and all-position welding and is mainly used for welding carbon steel, high strength low alloy steel and stainless steel. Welding robots mostly use the MAG process.

Metal inert gas welding (MIG): Uses Argon (Ar), Helium (He) or Ar-He mixtures as the shield gas and it is mainly used for welding aluminium and its alloys.

CO² (carbon dioxide) gas shielded arc welding (CO² welding): It uses CO² as the shield gas and is usually used in globular transfer and short circuit transfer to implement welding. It can be used to weld in different positions. As compared with other welding methods, CO² welding has many advantages, though it produces more spatters, CO² welding is widely used for general metal structure welding.

Output connections

Electrode polarity

In general when using manual arc welding electrodes the electrode holder is connected to the positive terminal and the work return to the negative terminal. Always consult the electrode manufacturer's data sheet if you have any doubts.

If using the machine for TIG welding, the gas valve type TIG torch should be connected to the negative terminal and the work return to the positive terminal.

Installation

MIG welding

Insert the welding torch into the “Euro connector for torch in MIG” output socket on the front panel of the wire feed unit and tighten it.

Insert the quick plug of the interconnection cable set into the “+” output terminal of the welding machine and tighten it clockwise (ensure to connect the other end connection to the rear of the wire feed unit).

Insert the work return lead cable plug into the “-” output terminal on the front panel of the welding machine and tighten it clockwise.

Select your wire size and place the reel of wire onto the spindle adapter of the wire feed unit. The wire spindle incorporates a friction brake which is adjustable to ensure optimum braking. If necessary, you can adjust by turning the large allen key inside the open end of the wire reel hub. Clockwise rotation will tighten the brake.

Correct adjustment will result in the reel circumference continuing no further than 15-20mm after releasing the torch trigger so the wire on the reel is slack but not too much where it will fall off the reel.

The gas cylinder should be equipped with the appropriate gas regulator. Connect the supplied gas hose to the gas inlet on the back panel of the machine and then to the outlet of the gas regulator.

Shielding gas offers protection to the weld area, so ensuring you have enough gas flow is very important.

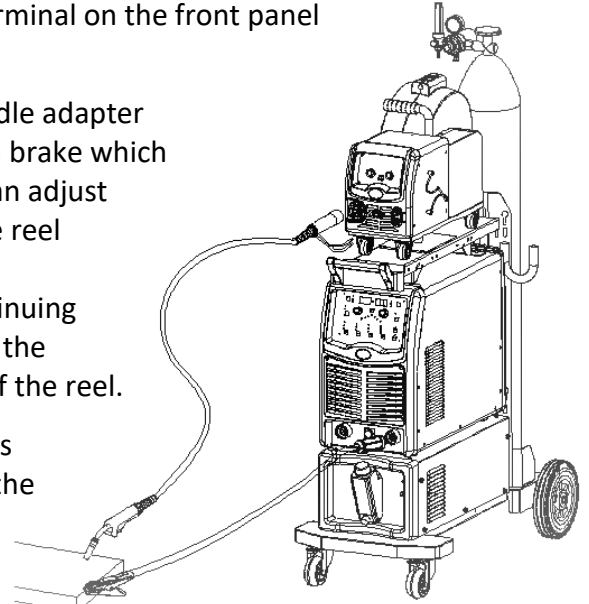

Ensure that the feed roll groove size that will be feeding the welding wire on the drive roll matches the contact tip size of the welding torch and the welding wire size being used.

Release the pressure arm of the wire feeder to thread the wire through the guide tube and into the drive roll groove and then adjust the pressure arm, ensuring no slipping of the wire when feeding through the torch. (Too much pressure will lead to wire distortion which will affect wire feeding).

Press the wire inch button to thread the wire out of the torch through the contact tip.

You are now ready to start MIG welding.

MMA welding

Insert the cable plug with electrode holder into the “+” socket on the front panel of the welding machine and tighten it clockwise.

Insert the cable plug of the work return lead into the “-” socket on the front panel of the welding machine and tighten it clockwise.

You are now ready to start MMA welding.

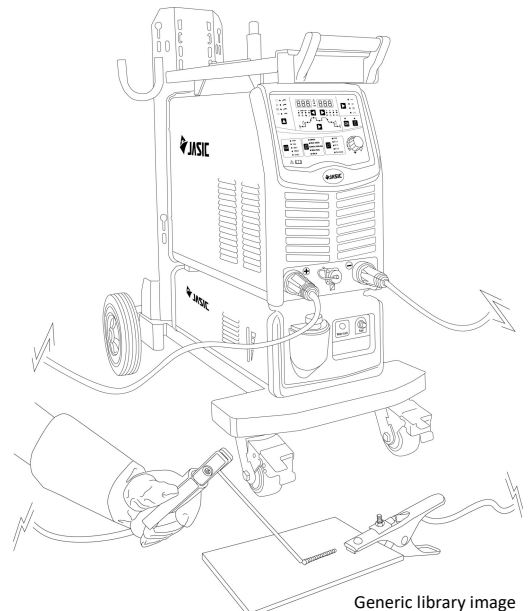

Generic library image

CONTROL PANEL

Front control panel view Jasic MIG JM-500P

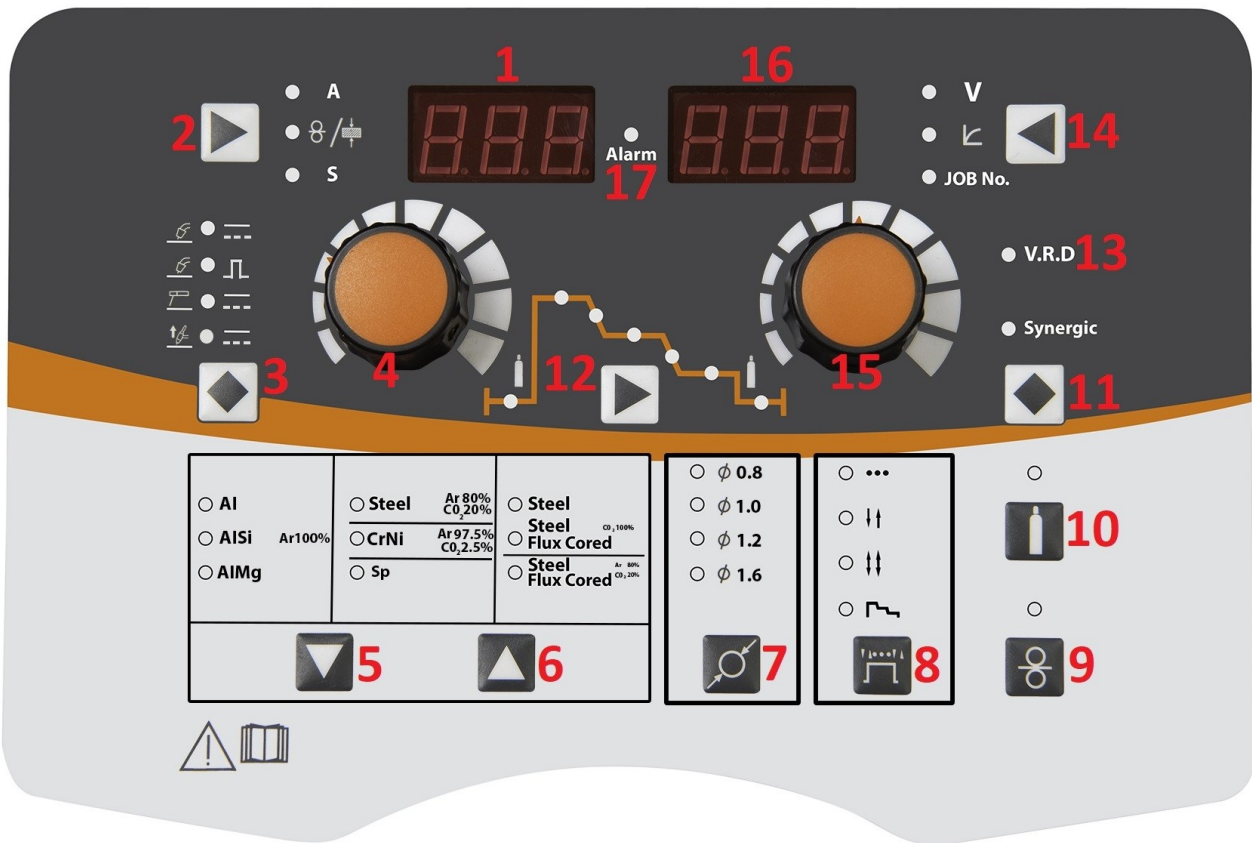

1. Digital display which shows either amperage, Wire feed speed/material thickness and time
2. Selector button to access, Amps, Wire speed or material thickness and time functions (see page 16 for further information)
3. Selector button for process mode. Can select MIG, MIG Pulse, MMA or Lift TIG (see page 17 for further information)
4. Rotary encoder: Used for carrying out adjustments which would be noted in display 1
5. Material selector button down. Pressing this button moves the selector to light the LED of the material to be welded (see page 19 for further information)
6. Material selector button up: Pressing this button moves the selector to light the LED of the material to be welded (see page 19 for further information)
7. Wire diameter selector button (see page 19 for further information)
8. Torch trigger selector button (see page 17 for further information)
9. Wire inch button (see page 17 for further information)
10. Gas purge button (see page 17 for further information)
11. Synergic selector button: Turns synergic mode on or off (see page 18 for further information)
12. Parameter selector button which will scroll through parameters such as pre-gas, welding currents, slope, crater current and post gas (see page 17 and 18 for further information)
13. VRD indicator led: The VRD LED will be ON when VRD is active in MMA mode
14. Selector button used to access voltage, Arc force (Inductance in MIG mode and arc force in MMA mode) and job storage functions (see page 16 and 20 for further information)
15. Rotary encoder: For carrying out parameter adjustments which are shown in display 16
16. Digital display which will show either voltage, arc force/inductance or job storage information
17. Alarm LED, used in conjunction with error codes (see page 19 and 58 for further information)

CONTROL PANEL

Digital display - current column parameters selecting zone

- Current
- Wire feed speed
- Base metal thickness

The current column parameters include 4 adjustable parameters:

- ⇒ Current (A)
- ⇒ Wire feed speed (m/min) *
- ⇒ material thickness of base metal (mm) *
- ⇒ Time (s),

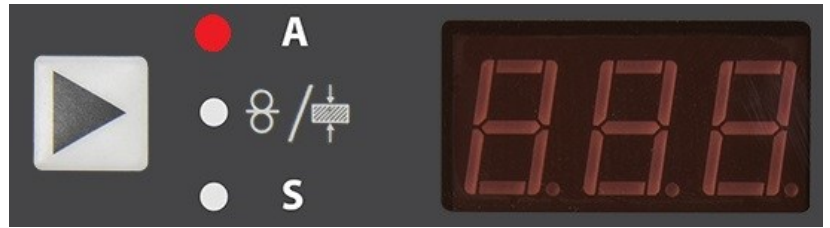

Please note: * On the JM-500P the default factory setting for MIG Standard or MIG pulse is set to wire feed, if you require the adjustment to be material thickness you then need to enter the background sub menu to change the default, see page 60 for further information.

The current column parameters display meter will display system information, actual welding current and the contents of the column parameters.

The operator can select the desired parameters by pressing the selecting key, the corresponding LED will then illuminate to indicate which parameter is selected. Meanwhile, the contents of the selected parameter will be displayed on the meter.

Please Note:

The display meter will display the actual current when there is welding current output.

To adjust a parameter, the users should make the corresponding LED flash by pressing the selecting key.

Digital display - voltage column parameters selecting zone

- Voltage
- Arc characteristic
- Job No

The voltage column parameters include 3 adjustable parameters:

- ⇒ Voltage (V),
- ⇒ Arc characteristic (-/+ (Inductance in MIG/MAG and Arce force in MMA mode)
- ⇒ Memory job recall and save info



The voltage column parameters display meter can display system information, actual welding voltage and the contents of the column parameters. Users can select the desired parameters by pressing the selecting key, the corresponding LED will then illuminate to indicate which parameter is selected. Meanwhile, the contents of the selected parameter will be displayed on the meter.

Please Note:

The meter will display the actual voltage when the main power circuit is connected.

To adjust a parameter, the users should make the corresponding LED flash by pressing the selecting key.

CONTROL PANEL

Parameter adjustment knob

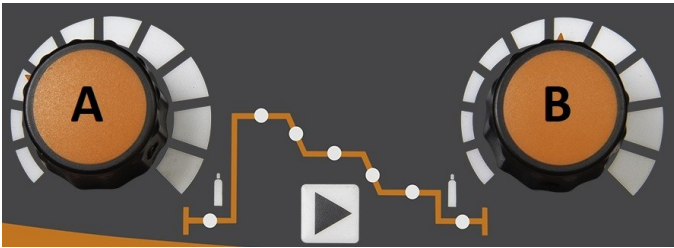

All welding parameters are set by adjusting the shown control potentiometer knobs A or B. The adjustment indicator tells users that the knob is effective when the corresponding parameter LED in the current column or voltage column flashes. Dial A will generally make adjustments to the left display and dial B will generally make adjustments

to the right hand display. In synergic mode depending on the selected parameter the left hand dial will make adjustments on both displays.

Welding mode selection

The welding process mode area is where you can select any of the 4 welding modes:

- Standard DC MIG/MAG
- Pulse MIG/MAG
- MMA
- Lift TIG

The operator can select the desired welding mode by pressing the selection key, the corresponding LED will illuminate according to your selection.

Note: The selected welding mode LED will blink during welding (when there is welding current output).



Trigger operating mode selection

Torch mode area of the panel is where the operator can select any of the 4 trigger operation modes, Spot welding, 2T, 4T and programmed 4T . Users can select the desired trigger operation mode by pressing the selection key, the corresponding LED will be illuminated when a certain trigger operation mode is selected. (see page 36 for further information)

Note: These function are not applicable in MMA.

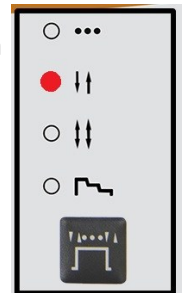

Gas purge button

This area contains components such as gas check key and gas flow LED. When the gas-check key is pressed once the gas will flow, press the button again to stop the gas flow.

The gas flow will automatically stop after 20 seconds.

The gas flow LED will illuminate while the gas purge is active.

Note: Users can stop gas flow by pushing the torch trigger in the gas-check state mode.

Wire inch button:

When pressing the wire inch button, the feed motor within the wire feed unit will feed the welding wire through the liner of the torch until it comes through the welding tip.

The wire inch LED will illuminate when the wire inch button is pressed.



CONTROL PANEL

Welding parameter selection

This area of the panel is where you can select the various parameters of the welding process. These parameters include:

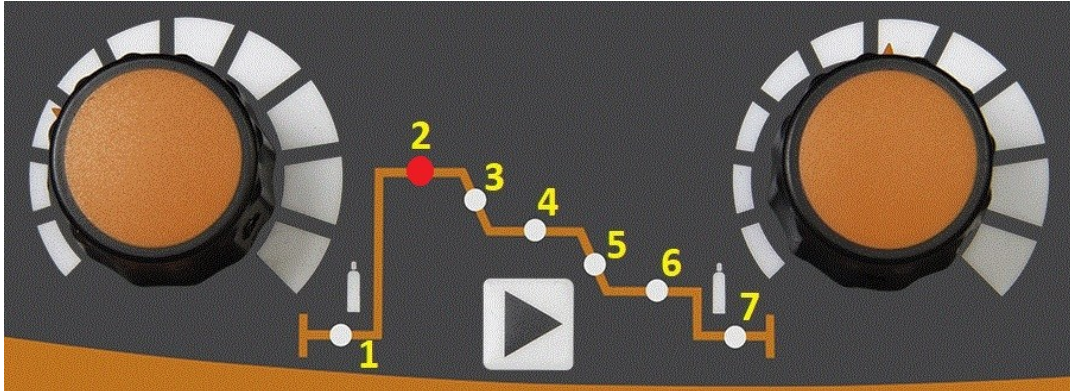

1. Pre-flow time
2. Initial current,
3. Slope time,
4. Welding current,
5. Slope down time to crater,
6. Crater level
7. Post flow gas time

Users can select the desired process parameter by pressing the selecting key, the corresponding LED will then illuminate to indicate which parameter is selected.

In some cases to select the parameters you wish to display or adjust, users may need to make a second choice through the current column or voltage column.

Synergic selector button.

This button allows the user to turn the synergic mode ON or OFF.

Synergic means that when a single setting is adjusted i.e. voltage or material thickness for example other settings like current or wire speed will also change.

On the JM-500P pulse machine, there are a multitude of pre-configured settings being changed by the software to provide the best weld possible.



VRD indicator led.

When MMA mode is selected the VRD light will illuminate to indicate that VRD is ON and your open circuit voltage (OCV) has reduced to 15V. See page 60 to access the submenu to turn VRD ON/OFF



CONTROL PANEL

Welding parameter selection

Wire diameter selecting zone

Welding wire diameter options include solid wire of:

- ⇒ Φ 0.8mm
- ⇒ Φ 1.0mm
- ⇒ Φ 1.2mm
- ⇒ Φ 1.6mm

The operator can select the desired wire diameter by pressing the selecting key and the corresponding LED will then illuminate to indicate which diameter sized wire is selected.

Note: This function is not applicable when MMA mode .

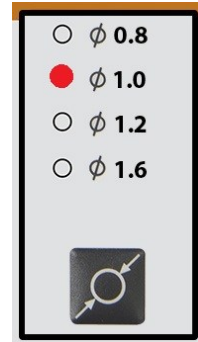

Base metal and gas selecting zone

This control allows you to select the base metal and welding gas mixture options which include:

- ⇒ Aluminium with 100% AR
- ⇒ Carbon steel with 80% Ar+20% CO₂
- ⇒ Carbon steel with 100% CO₂
- ⇒ Stainless Steel with 97% Ar+2.5% CO₂
- ⇒ Steel flux cored with 100% CO₂
- ⇒ Steel flux cored with 80% Ar+20% CO₂

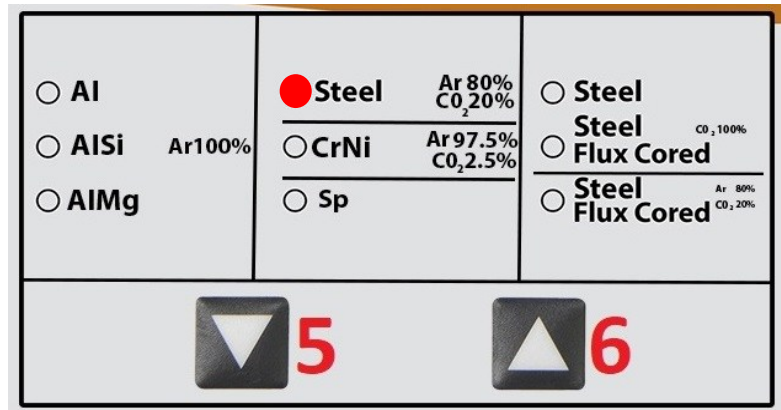

Users can select the desired base metal and gas combination by pressing the selecting keys 5 or 6 Pressing either of these buttons will move the selector to light the LED of the material/gas to be used.

Note: This function is not applicable when MMA mode.

Alarm Indicator

This LED will illuminate if the machine develops an error, please refer to the troubleshooting and error code sections for further information on page 58.

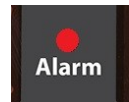

CONTROL PANEL

Saving welding Jobs via the Job No mode

For the simple and effective management of welding programs, the JM-500P machine is equipped with 20 channels (0 ~ 19) for storage of general MIG/MAG, synergic MIG/MAG and MMA welding programs.

A channel stores a sequence of all the parameters in a welding program you have created.

Take general MIG/MAG for example, a welding program includes parameters such as base metal type, gas type, wire diameter, trigger operation mode, pre-flow gas time, initial current, initial voltage, peak current, thickness of base metal, arc characteristic, peak voltage, crater current, crater voltage and post-flow gas time. All these parameters can then be saved in an empty channel for future use.

Channels are indicated with channel numbers and the working channel means the channel being used currently.

To create/store welding program:

First press button 'A' until the Job No LED illuminates which indicates that you have entered the channel management mode.

Please Note:

The machine when switched on will work in the Job No last used before the machine was switched off and this channel number will now be displayed on the voltage digital display 'D', if no jobs have been previously stored then Job No 0 will display.

At this time, users can change the working channel number by adjusting the control dial. (C)



With the desired channel number selected press button 'A' or any other key and the Job No LED will go off, and the channel management mode will be exited, from here you can then adjust the parameters as required (Material type, gas type, metal thickness etc.) and once you are happy with the settings simply carry out a weld and the settings will be automatically saved in the channel that you have just selected.

Please Note:

It's important to note that if you adjust the parameters and carry out a weld without changing to a new channel number, it will overwrite the parameters you had stored in that channel.

To avoid this it is recommended that you allocate a channel that you will use for general welding to avoid losing any previously stored programs.

To recall a previously stored welding program:

First press button 'A' until the Job No LED illuminates which accesses the channel management mode. This will show in the digital display the current job No being used, then rotate control dial 'C' until you have selected the desired job number, once selected, simply press button 'A' again to access the previously stored welding program.

Please note:

The machine when switched on will work in the channel last used before the machine was switched off and this channel number will now be displayed on the voltage column parameters display meter).

CONTROLS

Front control panel view of wire feed unit (Jasic MIG JM-500P)

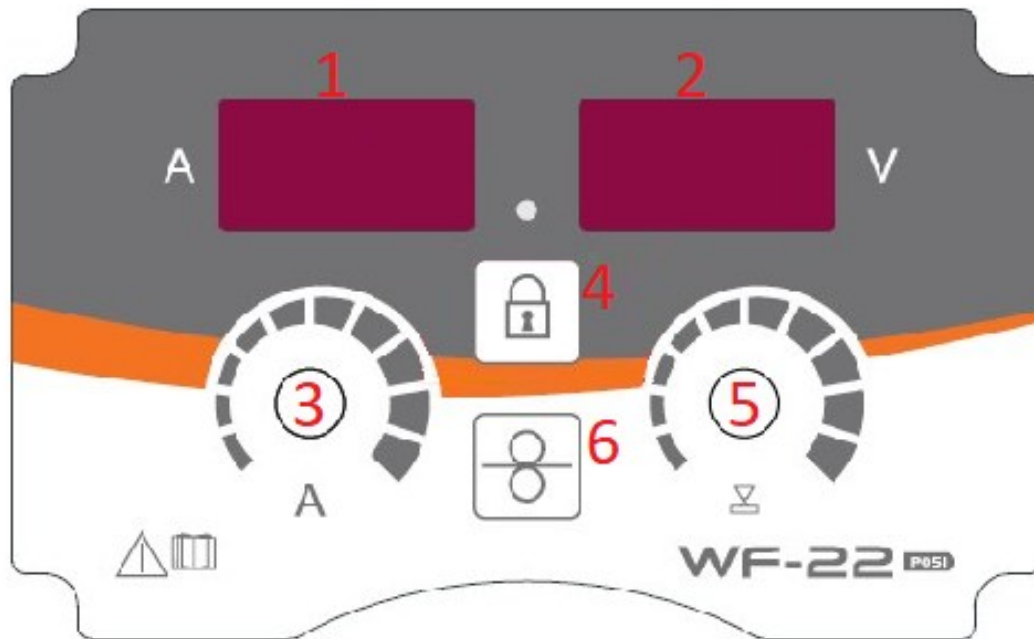

1. Digital display meter (ammeter)
2. Digital display meter (voltmeter in standard MIG mode and trim in synergic mode)
3. Amperage control dial
4. Lock button and LED (Locks the power source control panel controls)
5. Voltage or trim control dial
6. Wire inch button

OPERATING PARAMETERS

Parameter	Value	Jasic MIG JM-500P
MMA		
Welding current range	Amps	30 ~ 500
Arc force current range	Amps	0 ~ 250
Arc ignition current range	Amps	0 ~ 250
Arc ignition time	Seconds	500ms
MIG/MAG		
Pre-flow time	Seconds	0 ~ 3
Post-flow time	Seconds	0 ~ 10
Operation Mode	4 Modes:	MMA DC MIG/MAG Synergic MIG/MAG Pulse MIG/MAG
Wire feed speed range	m/min	1.4 ~ 23
Welding current range	Amps	69 ~ 500
Base metal thickness range	mm	1.2 ~ 29.5
Welding voltage range	Volts	10 ~ 50
Inductance range	-	-10 ~ +10
Downslope time	Seconds	0.1 ~ 3.0

Please Note

Due to variations in manufactured products all claimed performance ratings, capacities, measurements, dimensions and weights quoted are approximate only. Achievable performance and ratings when in use can depend upon correct installation, applications and use along with regular maintenance and service.

OPERATION MMA



Before starting any welding activity ensure that you have suitable eye protection and protective clothing. Also take the necessary steps to protect any persons within the welding area.

MMA Welding Mode

MMA (Manual Metal Arc), SMAW (Shielded Metal Arc Welding) or just Stick Welding. Stick welding is an arc welding process which melts and joins metals by heating them with an arc between a covered metal electrode and the work.

Shielding is obtained from the electrode outer coating, often called flux. Filler metal is primarily obtained from the electrode core.

The electrodes outer coating called flux assists in creating the arc and provides a shielding gas and on cooling forms a slag covering to protect the weld from contamination.

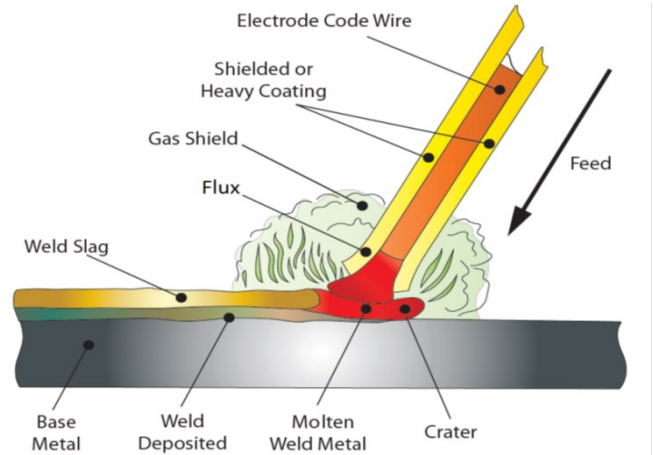

When the electrode is moved along the work piece at the correct speed the metal core deposits a uniformed layer called the weld bead.

After connecting the welding leads as detailed you will need to switch the power switch on the back panel to "ON".

Select the MMA mode by pressing the welding mode button until the MMA position LED lights up. There is now open circuit voltage output at both output terminals. The VRD LED may also have lit up.

Ensure you check that you have the electrode polarity correct and set the amperage on the machine suitable for the electrode being used.

Please see the guide to amperages required below, although this MMA welding electrode guide can vary depending on material, work piece thickness, welding position and joint form.

Electrode Diameter (mm)	Recommended Welding Current (A)
1.6	25 ~ 45
2.0	35 ~ 65
2.5	50 ~ 90
3.2	60 ~ 130
4.0	100 ~ 180
5.0	150 ~ 250
6.0	200 ~ 310

OPERATION MMA



Before starting any welding activity ensure that you have suitable eye protection and protective clothing. Also take the necessary steps to protect any persons within the welding area.

MMA Welding Mode

When selecting MMA (Manual Metal Arc) mode as shown below When welding in MMA modes, three parameters including hot start current, welding current and arc-force current are adjustable on the digital panel. Hot start current is at the “initial segment” of “welding process selection zone”; welding current is at “process” of “welding process selection zone”; arc-force current is at “MIG arc force, MMA Arc-force current indication” of “Voltage/arc force/parameters set, etc. displaying and setting zone”.-

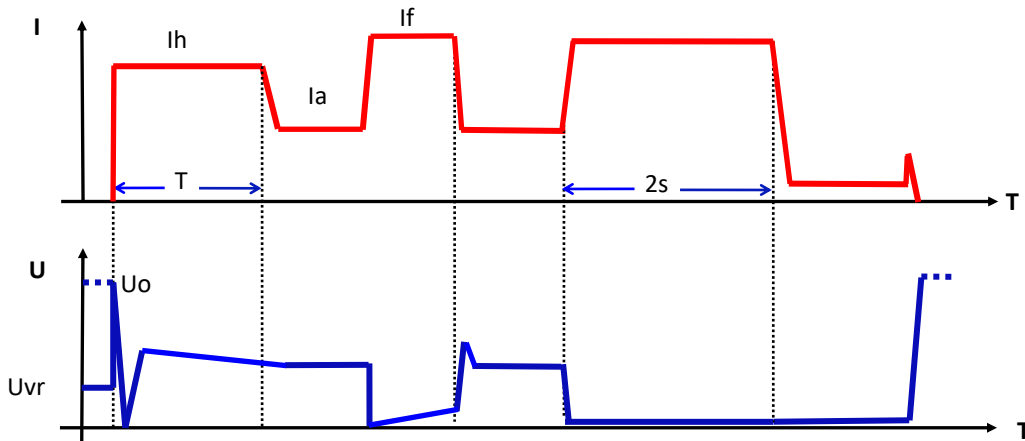
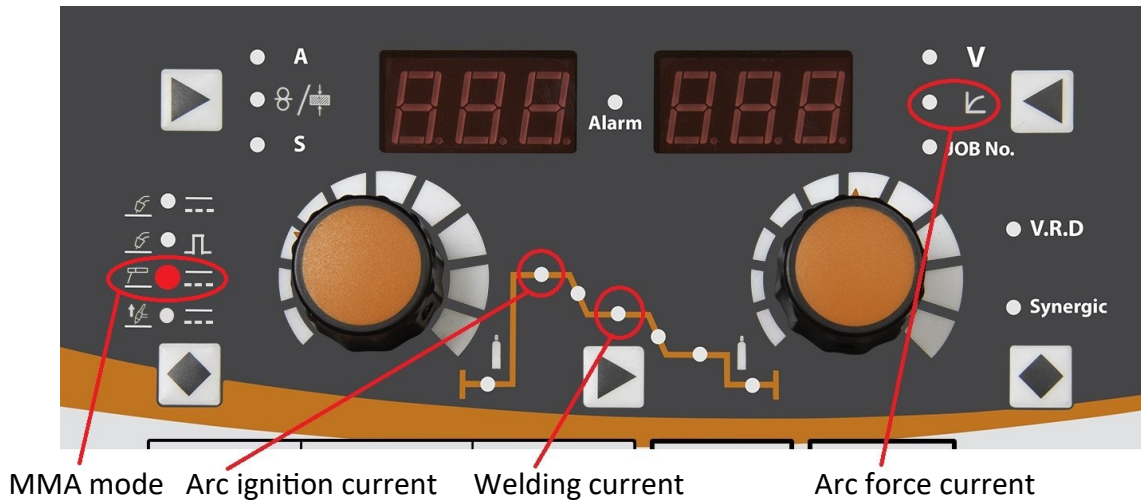

1. I_h (hot start current) = I_h (arc start current) + I_a (welding current). Fixed hot start time: $t_h = 500ms$
2. I_f (arc-force current) = I_f (arc-force current) + I_a (welding current).
Arc-force current should be set based on electrode diameter, set current and process requirement.
3. If the electrode is in short-circuit for 2 seconds, anti-stick current of 25A starts until electrode is separated from the workpiece.
4. U VRD is 15V, which conforms to the standard and is switched off by default. With VRD off the welding machines output will be full OCV (86V) when no welding is actively being carried out.
The VRD indicator informs the operator if VRD is active (ON) or not (OFF) in MMA mode, please go to page 60 for further information on how to turn VRD ON/OFF within the submenu

Model	Hot start current	Welding current	Arc-force current	Max current limit
MIG500P	0~250A	30~500A	0~250A	550A

OPERATION (MMA)



Before starting any welding activity ensure that you have suitable eye protection and protective clothing. Also take the necessary steps to protect any persons within the welding area.

MMA Welding Mode - Parameters in MMA

There are 3 adjustable parameters in MMA welding, namely arc ignition current, arc welding current and arc force. These parameters can be operated only through the control panel. Select the desired welding mode before any operation on parameters.

Arc ignition current (I1)

It is located at "initial segment-current column-current (A)". It indicates the current during arc ignition period and can be adjusted within the full range. Adjustment range is 0 ~ 250amps

Arc welding current (I2)

It is located at "peak segment-current column-current (A)" and users can set it according to their own technical requirements. Adjustment range is 30 ~ 500amps

Arc force

It is located at "peak segment-current column-arc characteristic (-/+)". It determines the rising rate of I3 and it should be set according to the electrode diameter, preset current and the technical requirement. If the arc force is large, the molten drop can be transferred quickly and electrode sticking seldom occurs. However, too large an arc force may lead to excessive spatter. If the arc force is small, there will be little spatter and the weld bead will be shaped well. However, too small an arc force may lead to soft arc and electrode sticking. Therefore, the arc force should be increased when welding with a thick electrode under low current. Adjustment range is 0 ~ 250amps

Please Note:

For simple TIG welding, set the arc characteristic (arc force) at 0 in MMA welding and simple TIG welding can be carried out. Simple TIG welding is a kind of DC TIG welding achieved by users in MMA welding through adding the necessary equipment.

Operation tips

Arc ignition mode in MMA (arc force)

Low current arc ignition:

It can be also called lift/soft arc ignition. Set the arc ignition time to be a value other than 0 and the arc ignition current (I1) to be a value lower than I2 and the machine will enter into low current arc ignition mode. Touch the work piece with the electrode and lift the electrode to the normal position to weld after arc is ignited.

High current arc ignition:

It can be also called contact/hot start arc ignition. Set the arc ignition time to be a value other than 0, and the arc ignition current (I1) to be a value not lower than I2 and the machine will enter into high current arc ignition mode. Touch the work piece with the electrode and normal welding can be carried out without lifting the electrode.

GUIDE TO MMA WELDING



Before starting any welding activity ensure that you have suitable eye protection and protective clothing. Also take the necessary steps to protect any persons within the welding area.

Notes for the welding beginner

This section is designed to give the beginner who has not yet done any welding some information to get them going. The simplest way to start is to practice by running weld beads on a piece of scrap plate. Start by using mild steel (paint free) plate of 6.0mm thick and using 3.2mm electrodes. Clean any grease, oil and loose scale from the plate and fix firmly to your work bench so that welding can be carried out. Make sure that the work return clamp is secure and making good electrical contact with the mild steel plate, either directly or through the work table. For best results always clamp the work lead directly to the material being welded, otherwise a poor electrical circuit may create itself.

Welding position

When welding, ensure you place yourself in a comfortable position for welding and your welding application before you begin to weld. This maybe sitting at a suitable height which often is the best way to weld ensuring you're relaxed and not tense. A relaxed posture will ensure the welding task becomes much easier.

Please ensure you always wear suitable PPE and use suitable fume extraction when welding.

Place the work so that the direction of welding is across, rather than to or from your body. The electrode holder lead should always be clear of any obstruction so that you can move your arm freely along as the electrode burns down. Some elders prefer to have the welding lead over their shoulder, this allows greater freedom of movement and can reduce the weight from your hand.

Always inspect your welding equipment, welding cables and electrode holder before each use to ensure it's not faulty or worn as you may be at risk of an electric shock.

MMA process features and benefits

The versatility of the process and the skill level required to learn, basic simplicity of the equipment make the MMA process one of the most common used throughout the world.

The MMA process can be used to weld a wide variety of materials and is normally used in the horizontal position but can be used in vertical or overhead with the correct selection of electrode and current. In addition, it can be used to weld at long distances from the power source subject to the correct cable sizing. The self shielding effect of the electrode coating makes the process suitable for welding in external environments. It is the dominant process used in maintenance and repair industries and is used extensively in structural and fabrication work.

The process is well able to cope with less than ideal material conditions such as dirty or rusty material. Disadvantages of the process are the short welds, slag removal and stop/starts which lead to poor weld efficiency which is in the region of 25%. The weld quality is also highly dependent on the skill of the operator and many welding problems can exist.

GUIDE TO MMA WELDING



Before starting any welding activity ensure that you have suitable eye protection and protective clothing. Also take the necessary steps to protect any persons within the welding area.

MMA process tips and guides

Typical welder set up

1. Electrode holder
2. Work return clamp
3. Work piece
4. Weld material covered by electrode flux or slag
5. Electrode
6. Distance from work to electrode (arc Length)

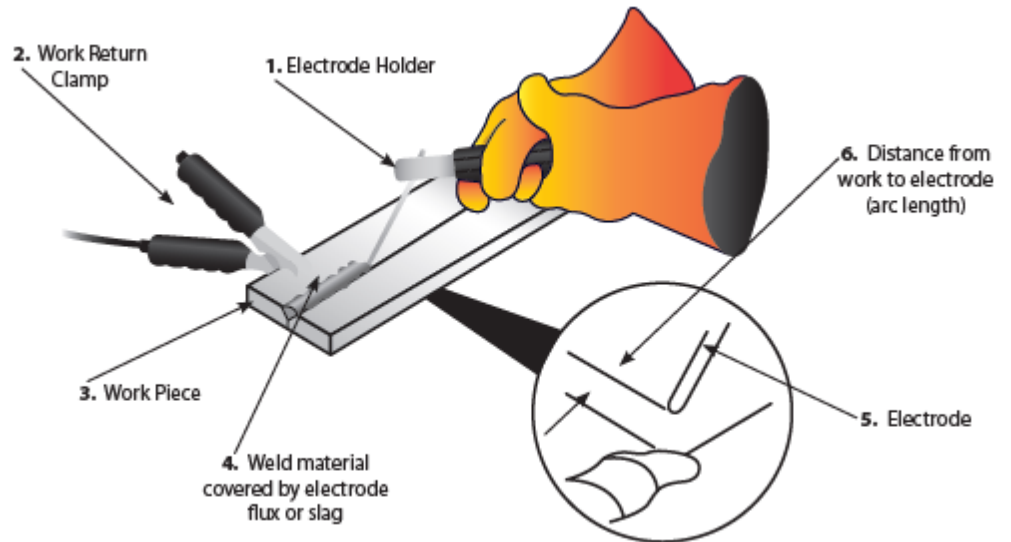

Welding current will flow in the circuit as soon as the electrode contacts the work piece. The welder should always ensure a good connection of the work clamp. The nearer the clamp is placed to the welding area the better.

When the arc is struck the distance between the end of the electrode and the work will determine the arc voltage and also affect the weld characteristic. As a guide the arc length for electrodes up to 3.2mm diameter should be around 1.6mm and over 3.2mm around 3mm.

Upon completion of the weld the welding flux or slag will need to be removed usually with a chipping hammer and wire brush.

Joint form in MMA

In MMA welding, the common basic joint forms: butt joint, corner joint, lap joint & T joint.

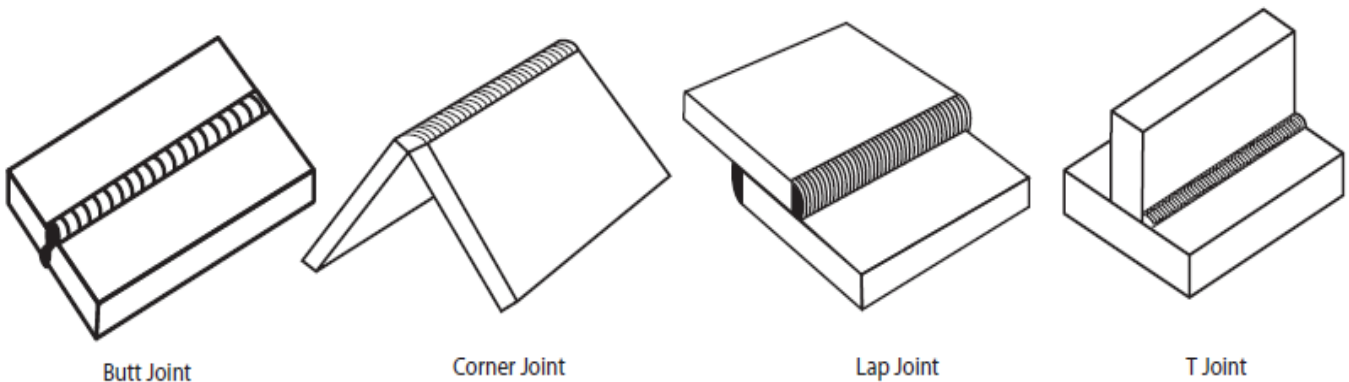

Butt Joint

Corner Joint

Lap Joint

T Joint

GUIDE TO MMA WELDING



Before starting any welding activity ensure that you have suitable eye protection and protective clothing. Also take the necessary steps to protect any persons within the welding area.

MMA arc striking

Tap technique - Lift the electrode upright and bring it down to strike the work piece. After forming short circuit, quickly lift up about 2~4mm and arc will be ignited. This method is difficult to master.

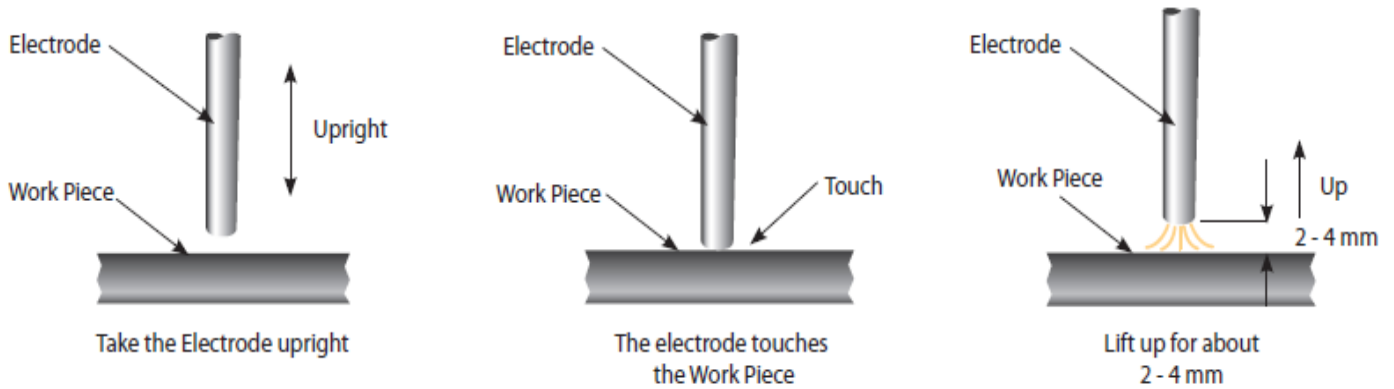

Scratch technique - Drag the electrode and scratch the work piece as if striking a match. Scratching the electrode may cause the arc to burn along the scratch path, so care should be taken to scratch in the weld zone. When the arc is struck adopt the correct welding position.

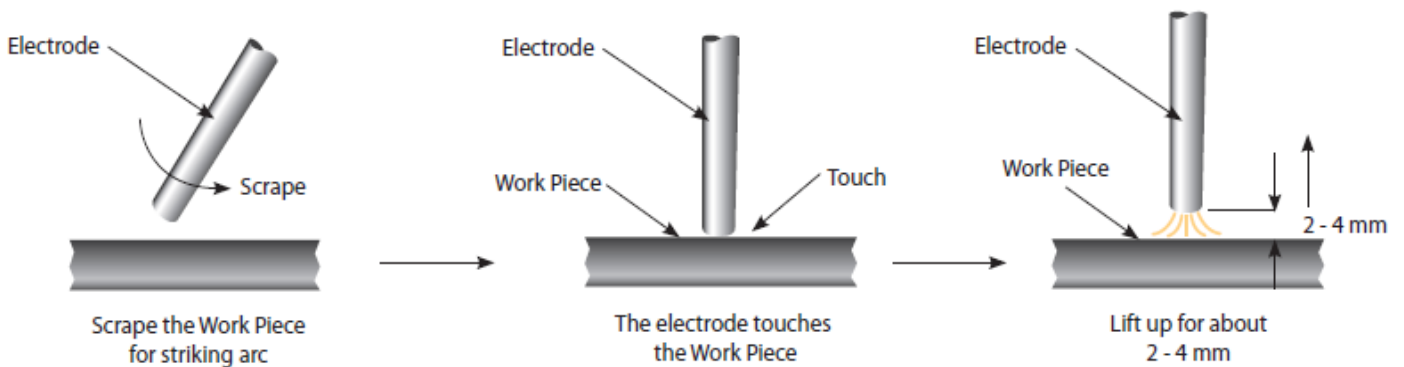

Electrode positioning

Horizontal or flat position

The electrode should be positioned at right angles to the plate and inclined in the direction of travel at around 10°-30°.

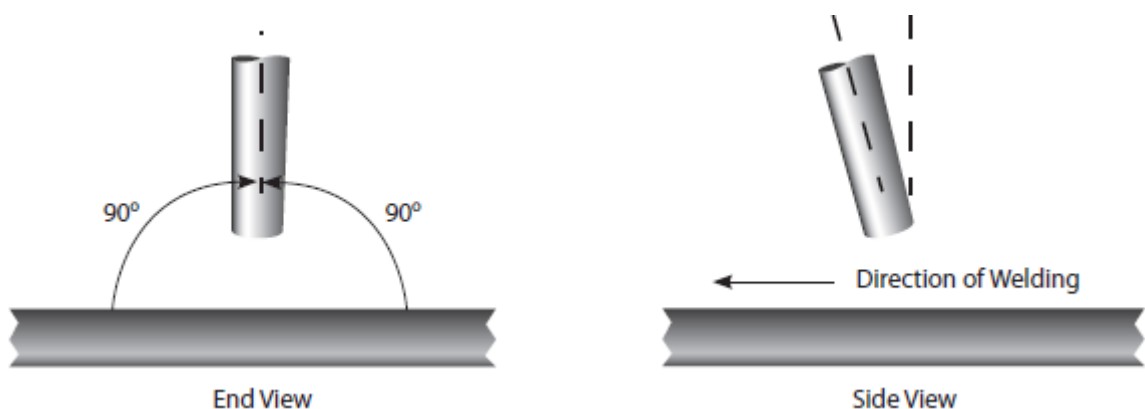

GUIDE TO MMA WELDING



Before starting any welding activity ensure that you have suitable eye protection and protective clothing. Also take the necessary steps to protect any persons within the welding area.

Fillet welding

The electrode should be positioned to split the angle i.e. 45° . Again the electrode should be inclined in the direction of travel at around 10° - 30° .

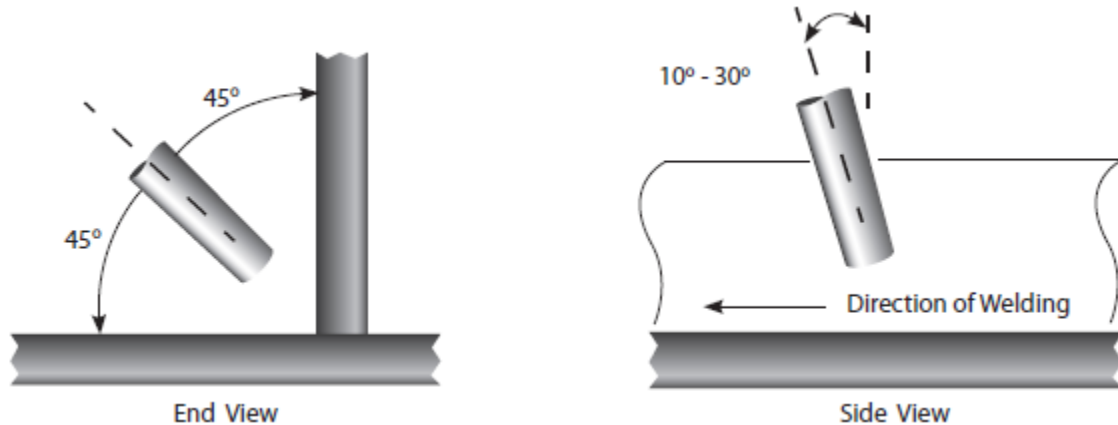

Manipulation of electrode

In MMA welding there are three motions used at the end of electrode:

1. The electrode feeding to the molten pool along axes
2. The electrode swing right and left
3. The electrode moving in the weld direction

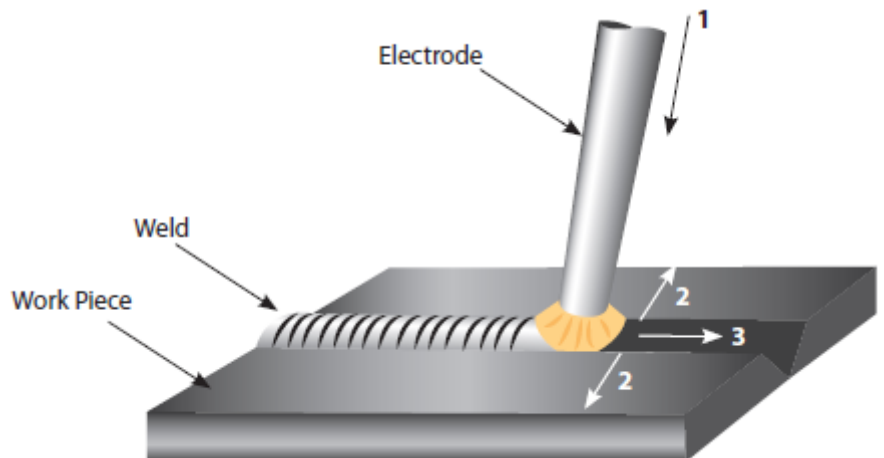

The operator can choose the manipulation of electrode based on welding joint, welding position, electrode spec, welding current and operation skill etc.

Weld characteristics

A good weld bead should exhibit the following characteristics:

1. Uniform weld bead
2. Good penetration into the base material
3. No overlap
4. Fine spatter level

A poor weld bead should exhibit the following characteristics:

1. Uneven and erratic bead
2. Poor penetration into the base material
3. Bad overlap
4. Excessive spatter levels
5. Weld crater

MMA WELDING PROBLEMS



Before starting any welding activity ensure that you have suitable eye protection and protective clothing. Also take the necessary steps to protect any persons within the welding area.

Arc welding defects and prevention methods

<u>Defect</u>	<u>Possible cause</u>	<u>Action</u>
Excessive spatter (beads of metal scattered around the weld area)	Amperage too high for the selected electrode	Reduce amperage or utilise larger diameter electrode
	Voltage too high or arc length too long	Reduce arc length or voltage
Uneven and erratic weld bead and direction	Weld bead is inconsistent and misses joint due to operator	Operator training required
Lack of penetration – The weld bead fails to create complete fusion between material to be welded, often surface appears okay but weld depth is shallow	Poor joint preparation	Joint design must allow for full access to the root of the weld
	Insufficient heat input	Material too thick Increase the amperage or increase the electrode size and amps
	Poor weld technique	Reduce travel speed Ensure the arc is on the leading edge of the weld puddle
Porosity – Small holes or cavities on the surface or within the weld material	Work piece dirty	Remove all contaminant from the material i.e. oil, grease, rust, moisture prior to welding
	Electrode is damp	Replace or dry the electrode
	Arc length is excessive	Reduce the arc length
Excessive penetration – The weld metal is below the surface level of the material and hangs below	Heat input too high	Reduce the amperage or use a smaller electrode and lower amperage
	Poor weld technique	Use correct welding travel speed
Burning through – Holes within the material where no weld exists	Heat input too high	Use lower amperage or smaller electrode Use correct welding travel speed
Poor fusion – Failing of weld material to fuse either with the material to be welded or previous weld beads	Insufficient heat level	Increase the amperage or increase the electrode size and amperage
	Poor welding technique	Joint design must allow for full access to the root of the weld Alter welding technique to ensure penetration such as weaving, arc positioning or stringer bead technique
	Work piece dirty	Remove all contaminant from the material i.e. oil, grease, rust, moisture prior to welding

OPERATION MIG/MAG



Before starting any welding activity ensure that you have suitable eye protection and protective clothing. Also take the necessary steps to protect any persons within the welding area.

MIG/MAG Welding Mode

MIG - Metal Inert Gas Welding, MAG - Metal Active Gas Welding, GMAW - Gas Metal Arc Welding

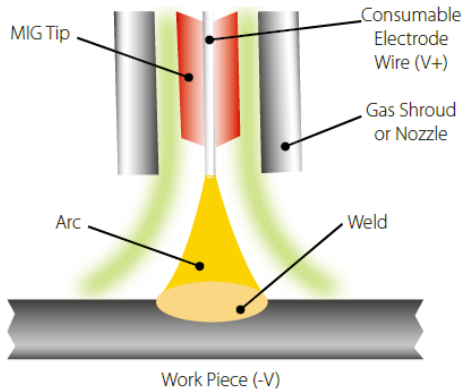

MIG welding was developed to help meet production demands of the war and post war economy which is an arc welding process in which a continuous solid wire electrode is fed through a MIG welding gun and into the weld pool, joining the two base materials together.

A shielding gas is also sent through the MIG welding gun and protects the weld pool from contamination which also enhances the arc.

Ensure that a suitable inert gas supply is connected.

Machine switch ON

Switch the power switch on the back panel to “ON”, the machine is started with the digital meters and control panel lit.

MIG selection

Switch the MMA/MIG switch to MIG mode.

Gas

Open the gas valve of the cylinder, then by pressing the gas purge switch on the front panel of the power source you can accurately adjust the gas regulator to obtain the desired flow rate.

Digital displays

At this time, for the digital displays will be lit. The required parameters can be set in accordance of what is required (Please refer to the controls section on page 16 for details of parameter setting options). These parameters can be adjusted selecting the parameter to be adjusted and then using the control knob or button to make the adjustment.

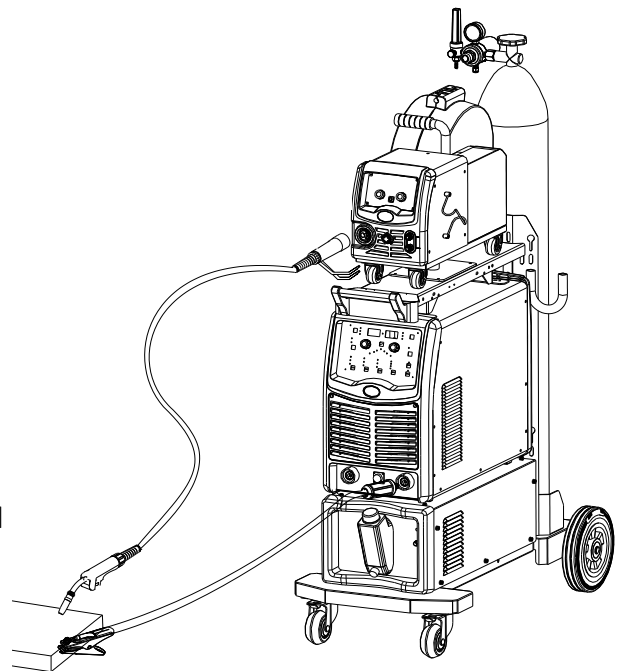

Torch trigger control

There are 4 trigger modes, spot, 2T, 4T and repeat.

Select the operation of torch trigger modes you require.

In 2T mode, arc is ignited by pushing the torch trigger and the arc stops by releasing the torch trigger.

In 4T mode, welding can be continued when releasing the torch trigger after arc is ignited and at this time, welding parameters can be adjusted using the current control knob (wire feed speed) and voltage control dials on the wire feed unit.

When pushing the torch trigger again, the machine then enters into crater welding and at this time, the crater parameters can be set by adjusting the crater current or voltage control dials on the front panel of the power source.

OPERATION (MIG/MAG)



Before starting any welding activity ensure that you have suitable eye protection and protective clothing. Also take the necessary steps to protect any persons within the welding area.

Control panel operation and setup

After the machine is powered on, the system will be under the functional state that was used last time the machine was powered off. If users want to continue the original welding task, there is no need to make any adjustments, just continue welding as before. However, if users want to change the welding task or welding instruction, they should make any changes using the control panel.

The recommended operation steps for the control panel are as below.



1. **Select the welding mode:** Select the desired welding mode by pressing the selecting key in the welding mode selecting zone if necessary.
2. **Select the base metal & gas type:** Select the desired base material and combined gas type by pressing either selecting key in the base metal/gas selecting zone if necessary.
3. **Select the welding wire diameter:** Select the desired welding wire diameter by pressing the selecting key in the wire selecting zone if necessary.
4. **Select the trigger operation mode:** Select the desired operation mode by pressing the selecting key in the trigger operation mode selecting zone if necessary.
5. **Select synergic mode:** Select if you require to use synergic mode by pressing the selecting key.
6. **Select the material thickness:** Select the desired material thickness setting that matches the base material being welded by pressing the required selection key until the LED illuminates and then using the parameter adjustment knob to adjust the material thickness shown in the left digital display
Note: Please ensure you have the material thickness option selected in the submenu, see page 60.

Select the parameter to be viewed or modified

If necessary, select the segment, to which the parameter to be viewed belongs, by pressing the selecting key in the welding process parameters selecting zone, and then select this parameter by pressing the selection key in the current column parameters selecting zone or voltage column parameters selecting zone, and the current value of this parameter will be displayed on the current column or voltage column parameters display meter. Users can modify this parameter by adjusting the control knob when the corresponding parameter LED flashes.

OPERATION (MIG/MAG)



Before starting any welding activity ensure that you have suitable eye protection and protective clothing. Also take the necessary steps to protect any persons within the welding area.

Wire feed unit control panel operation and setup

Wire feed unit control

Once the machine has been set up, the operator does have the ability to make welding adjustments via the wire feed unit panel.

The adjustments come via the 2 potentiometers, the amperage control knob and the voltage trim control Knob. The below offers an explanation of how these settings affect the welding performance of the JM-500P.

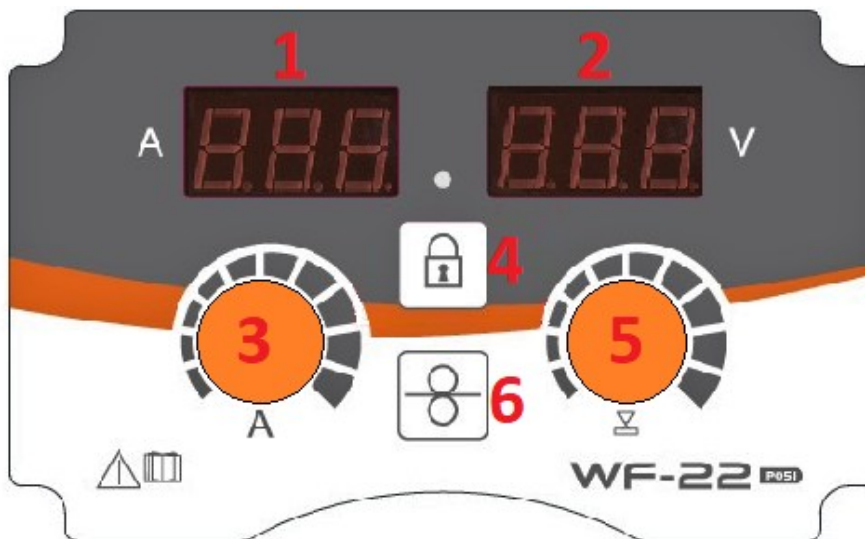

1. **Amperage digital meter:** The digital ammeter display will show the operator the 'preset' amperage during setup that corresponds with the synergic program being set or used, for example if you change the base material thickness the amperage displayed will also change to reflect the program difference.
2. **Voltage trim digital meter:** The digital voltage trim display will show the operator the trim voltage that's been set via the voltage trim potentiometer (5)
3. **Amperage control dial:** The amperage trim control dial will adjust the wire feed speed and voltage within the set synergic program according to your desired requirements, its important to remember that adjusting this control will not just change the wire feed speed, it will also adjust the welding voltage also
4. **Lock button and LED:** The lock button (4) when pressed will prevent accidental adjustment of any control button or potentiometer on the control panel of the power source of the machine, the only control that will function are those located on the wire feed unit. When lock is active the lock LED will illuminate. To deactivate the lock control, press the lock button again and the lock button LED will turn off.
5. **Voltage trim control dial:** The voltage trim (located on the wire feed unit), when in synergic mode can be used to fine-tune the voltage parameter within a synergic program you have setup. By rotating the dial clockwise, you will increase the voltage by a maximum of 9.9V; this will give the effect of having less wire and a longer arc length. In contrast, rotating the dial anticlockwise will reduce the voltage by a maximum of -9.9V; this will give the effect of having more wire and a shorter arc length. When the display reads 0.0, you are at the suggested synergic setting.
Please Note: If in standard MIG mode then the voltage trim function will adjust welding voltage
6. **Wire inch button:** The wire inch button will feed the wire through the liner of the torch until it comes through the welding tip

OPERATION (MIG/MAG)



Before starting any welding activity ensure that you have suitable eye protection and protective clothing. Also take the necessary steps to protect any persons within the welding area.

MIG/MAG Welding Mode - Parameters in MIG

There are 16 adjustable parameters in standard MIG/MAG welding, namely pre-flow time, initial current, initial speed, initial voltage, upslope time, peak current, peak speed, peak voltage, thickness of base metal, arc characteristic, spot welding time, downslope time, crater current, crater speed, crater voltage and post-flow time. 9 of these parameters, namely peak current, peak speed, peak voltage, thickness of base metal, arc characteristic, spot welding time, crater current, crater speed, crater voltage can be operated either through the control panel on the power supply or through the control panel on the wire feeder part, and other parameters can be operated only through the control panel on the power supply part. Select the desired welding mode, base metal type, gas type, welding wire type and operation mode before any operation on parameters.

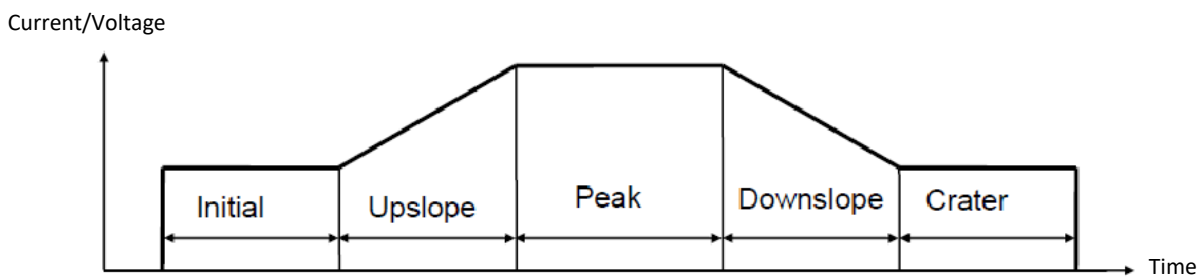

Welding current and welding voltage in general MIG/MAG

1. Pre-flow time

It is located at “pre segment-voltage column-time (s)”, and users can set it according to their own technical requirements.

2. Initial current

It is located at “initial segment-current column-current (A)”, and it varies with the change of the initial speed. Therefore, it is unnecessary to set this parameter when the initial speed is set properly.

3. Initial speed

It is located at “initial segment-current column-wire feed speed (m/min)”, and it varies with the change of the initial current. Therefore, it is unnecessary to set this parameter when the initial current is set properly.

4. Initial voltage

It is located at “initial segment-voltage column-voltage (V)”, and it varies with the change of the initial current or initial speed. Beside, this parameter can be adjusted within a certain range.

5. Upslope time

It is located at “upslope segment-voltage column-time (s)”, and it is only used in programmed 4T mode.

6 Peak current

It is located at “peak segment-current column-current (A)”. Since peak current, peak speed and thickness of base metal are interacting parameters, if one of them varies, the other two will be changed. Generally, users may choose one of the three to operate according to their own technical requirements or operation habits, leaving the other two parameters out of consideration.

OPERATION (MIG/MAG)



Before starting any welding activity ensure that you have suitable eye protection and protective clothing. Also take the necessary steps to protect any persons within the welding area.

MIG/MAG Welding Mode - Parameters in MIG

7 Peak speed

It is located at “peak segment-current column-wire feed speed (m/min)”. For the relative description, see the contents of peak current (previous page) for reference.

8 Thickness of base metal

It is located at “peak segment-current column-thickness of base metal (mm)”. For the relative description, see the contents of peak current above for reference.

9 Peak voltage

It is located at “peak segment-voltage column-voltage (V)”, and it varies with the change of the peak current and its interacting parameters. This parameter can be adjusted independently within a certain range.

10 Arc characteristic

It is located at “peak segment-current column-arc characteristic (-/+)”, and the recommended value of arc characteristic is 0. If the arc force is increased, the arc will be soft and there will be less spatter. If the arc force is reduced, the arc will be hard and there will be excessive spatter. This parameter is especially important when welding under low current. Users may adjust it according to their own technical requirements or operation habits.

11 Spot welding time

It is located at “peak segment-voltage column-time (s)”, and it makes sense only in spot welding.

12 Downslope time

It is located at “downslope segment-voltage column-time (s)”. The craters can be filled by adjusting this parameter properly in non programmed 4T mode.

13 Crater current

It is located at “crater segment-current column-current (A)”, and it varies with the change of the crater speed. Therefore, it is unnecessary to set this parameter when the crater speed is set properly.

14 Crater speed

It is located at “crater segment-current column-wire feed speed (m/min)”, and it varies with the change of the crater current. Therefore, it is unnecessary to set this parameter when the crater current is set properly.

15 Crater voltage

It is located at “crater segment-voltage column-voltage (V)”, and it varies with the change of the crater current or crater speed. Beside, this parameter can be adjusted independently within a certain range.

16 Post-flow time

It is located at “postposed segment-voltage column-time (s)”, and users can set it according to their own technical requirements.

OPERATION (MIG/MAG)



Before starting any welding activity ensure that you have suitable eye protection and protective clothing. Also take the necessary steps to protect any persons within the welding area.

MIG/MAG Burnback adjustment

When in pulse MIG mode the preset burn-back parameter setting will normally ensure that the welding arc will not climb the wire and fuse to the contact tip once you have stopped welding although the user can adjust burn-back if necessary.

Adjustment steps:

- Select welding post-flow (1) within the parameter area.
- Switch (2) time LED to wire feed speed/material thickness LED. At this time, the left digital display will show 1.00.
- Burnback time can be adjusted between 0.50~1.50 by using the left encoder (3).

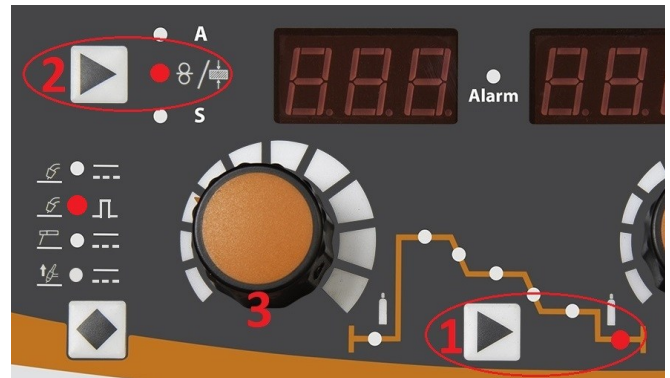

If the setting is decreased the burn-back time is increased. If the setting is increased, burn-back time is shortened. Once set this parameter will be applied to all welding wires.

Please note: 1.0 is the factory default setting after the JM-500P is restarted.

Mode Number	Operation	Torch trigger operation and current curve
1	1T/Spot welding mode: 1. Push the torch trigger: Arc is ignited and current rises to the preset value. 2. When the spot welding time is up, current drops gradually and arc stops. Note: Spot welding time is 1/10 of the upslope time.	
2	Standard 2T mode: 1. Push the torch trigger: Arc is ignited and current rises gradually. 2. Release the torch trigger: Current drops gradually and arc stops. 3. If the torch trigger is re-operated again before arc stops, the current will gradually rise again to status 2.	
3	Standard 4T mode: 1. Push the torch trigger: Arc is ignited and current reaches the initial value. 2. Release it: Current rises gradually. 3. Push it again: Current drops to pilot arc current value. 4. Release it: Arc stops.	
4	Programmed 4T mode: When the torch trigger is pressed the arc strikes at initial current/voltage. When the trigger is released the current/voltage slopes in over your "slope in time" to match the peak welding current/voltage you have set. Pressing the trigger again will gradually reduce the current/voltage to meet the "crater current" you have set. When the trigger is released, the arc will extinguish.	

MIG/MAG Trigger Modes

For further information on MIG/MAG torch trigger mode functionality in both standard and pulse modes, please see page 38.

OPERATION (MIG/MAG)



Before starting any welding activity ensure that you have suitable eye protection and protective clothing. Also take the necessary steps to protect any persons within the welding area.

DC Standard MIG/MAG Welding Mode - Parameter Settings

DC standard MIG/MAG has “synergic” and “standard (separate controls)” modes for welding voltage and welding current:

A. Synergic MIG

The machine contains synergic curves for different materials, gases and wire types. This means that by setting either current or material thickness all other parameters will be matched automatically. Changing either current or material thickness will automatically change other parameters.

There is a voltage trim where the welder can adjust the arc length when welding.

After choosing “synergic”, the machine panel’s left display will show preset current (or wire feed speed, workpiece thickness) and right display will show preset voltage. The wire feeder panel left display will show preset current and right display will show preset arc length. Current and voltage can be adjusted at the wire feed. The arc length standard is “0” Adjustment is based on synergic voltage, ranging between $\pm 9.9V$.

B. Standard MIG

The wire feed speed, material thickness adjustment has no relation with the voltage adjustment and requires parameters to be set individually and there is no ‘auto’ matching involved.

Please note: Its best when in standard MIG mode that you have wire feed speed option selected rather than material thickness, see page 60, menu No P5 for instructions on how to change this in the submenu.

Standard MIG/MAG setting

Using standard MIG/MAG, the adjustable parameters include: pre-flow time, welding specification of process: welding current (or wire feed speed/material thickness), welding voltage, arc force (inductance), welding specification of crater segment: welding current (or wire feed speed/material thickness), welding voltage, arc force (inductance), post-flow time.

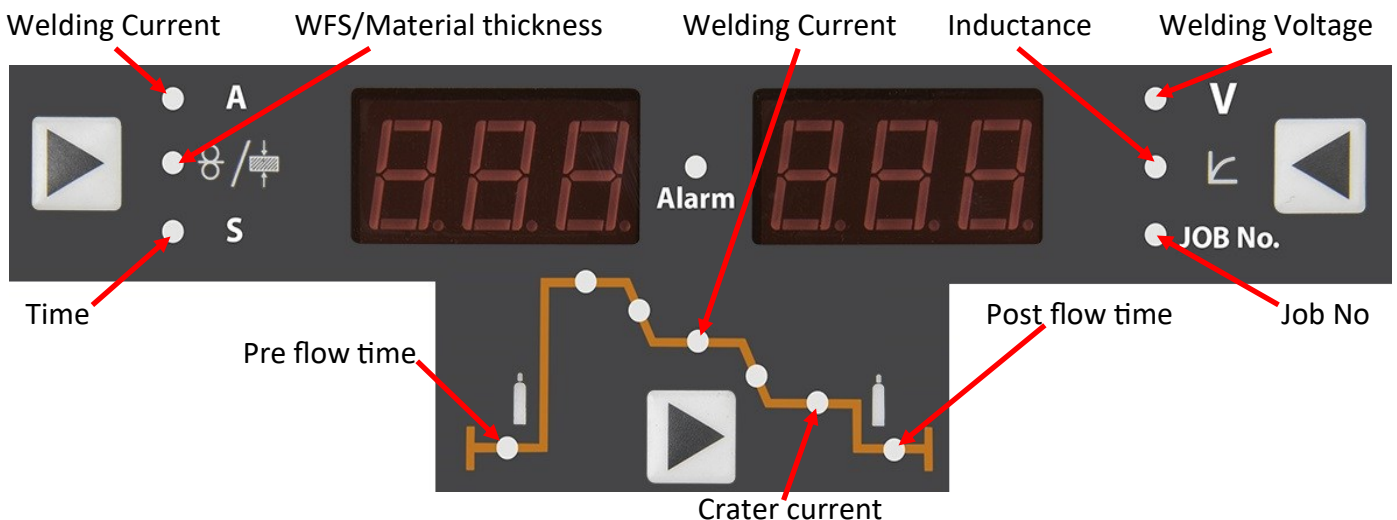

Model	Welding current	Welding voltage	Pre-flow time	Post-flow time	Arc force (inductance)
MIG500P	30 ~ 500A	10 ~ 50V	0 ~ 3.0s	0 ~ 10.0s	-10 ~ 10

Please Note: Different welding wire diameters have different welding current ranges. A different welding wire diameter at the same current has a different wire speed.

OPERATION (MIG/MAG)



Before starting any welding activity ensure that you have suitable eye protection and protective clothing. Also take the necessary steps to protect any persons within the welding area.

MIG/MAG Welding Mode - Standard DC MIG/MAG

MODE	Standard DC MIG/MAG welding process sequence
2T	<p>The 2T timing diagram shows the following sequence of events:</p> <ul style="list-style-type: none"> Torch switch: ON (during welding), OFF (during pre-flow and post-flow). Gas: Pre flow (before OCV), OCV (at start of welding), Burn back time (during welding), Post flow (after welding). Output voltage: Starts at OCV, drops at Post flow. Wire feed: Starts at OCV, drops at Post flow. Welding current: Starts at OCV, drops at Post flow. Welding processing: Indicated by a large arrow from OCV to Post flow.
4T	<p>The 4T timing diagram shows the following sequence of events:</p> <ul style="list-style-type: none"> Torch switch: ON (during welding), OFF (during pre-flow and post-flow). Gas: Pre flow (before OCV), OCV (at start of welding), Burn back time (during welding), Post flow (after welding). Output voltage: Starts at OCV, drops at Post flow. Wire feed: Starts at OCV, drops at Post flow. Welding current: Starts at OCV, drops at Post flow. A 'Crater current' is shown at the end of the welding current signal. Welding: Indicated by a large arrow from OCV to Post flow. Crater: Indicated by a smaller arrow at the end of the welding current signal.

OPERATION (MIG/MAG)



Before starting any welding activity ensure that you have suitable eye protection and protective clothing. Also take the necessary steps to protect any persons within the welding area.

MIG/MAG Welding Mode - Standard DC MIG/MAG

MODE	Standard DC MIG/MAG welding process sequence
Repeat	
Spot	

OPERATION (MIG/MAG)



Before starting any welding activity ensure that you have suitable eye protection and protective clothing. Also take the necessary steps to protect any persons within the welding area.

DC Pulse MIG/MAG Welding Mode - Parameter Settings

DC Pulse MIG/MAG When in DC Pulse, “synergic” mode for automatically selected and standard MIG mode is unavailable. In synergic mode, voltage can be adjusted with a focus on synergic voltage of $\pm 9.9V$.

Parameters setting

Using standard MIG/MAG, the adjustable parameters include: pre-flow time; welding specification of process: welding current (or wire feed speed/material thickness), welding voltage, arc force (inductance); welding specification of crater segment: welding current (or wire feed speed/material thickness), welding voltage, arc force (inductance); post-flow time.

Arc force: The arc force range is $-10 \sim +10$; 0 is the standard central value. If it is adjusted in the positive direction and arc will be harsher and the weld bead will be narrower. If adjusted to the negative direction, the arc will be softer and weld bead will be broadened. Arc force can be set respectively to the welding process, initial and crater settings.

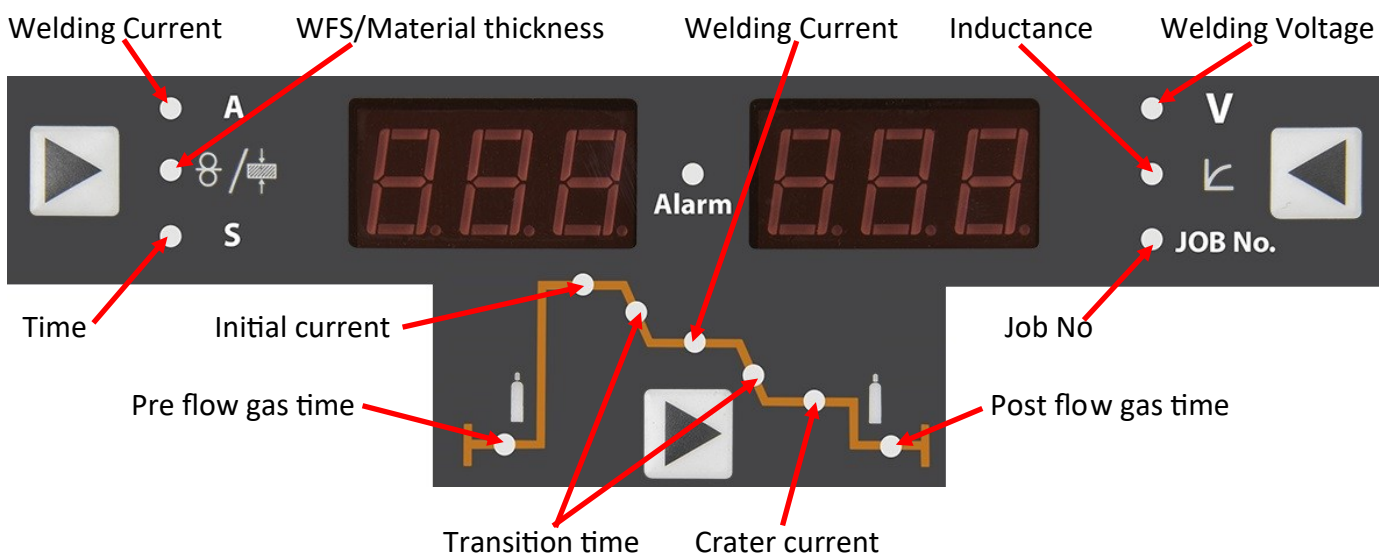

Please Note: Different welding wire diameters have different welding current ranges. A different welding wire diameter at the same current has a different wire speed.

Model	Welding current	Welding voltage	Transition time	Pre-flow time	Post-flow time	Arc force (inductance)
MIG500P	30 ~ 500A	10 ~ 50V	0.1 ~ 3.0s	0 ~ 3.0s	0 ~ 10.0s	-10 ~ 10

OPERATION (MIG/MAG)



Before starting any welding activity ensure that you have suitable eye protection and protective clothing. Also take the necessary steps to protect any persons within the welding area.

MIG/MAG Welding Mode - Pulse DC MIG/MAG

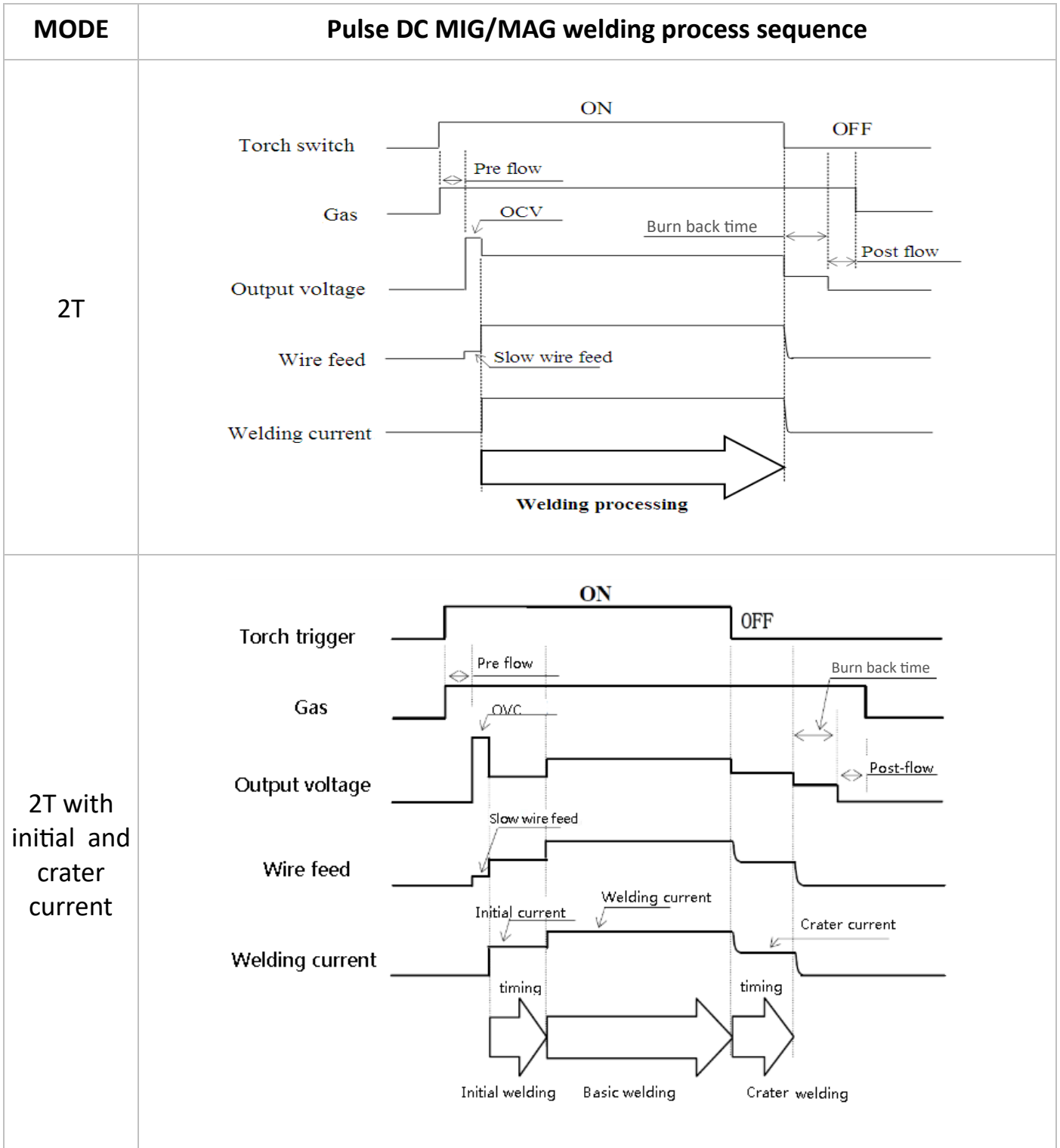

OPERATION (MIG/MAG)



Before starting any welding activity ensure that you have suitable eye protection and protective clothing. Also take the necessary steps to protect any persons within the welding area.

MIG/MAG Welding Mode - Pulse DC MIG/MAG

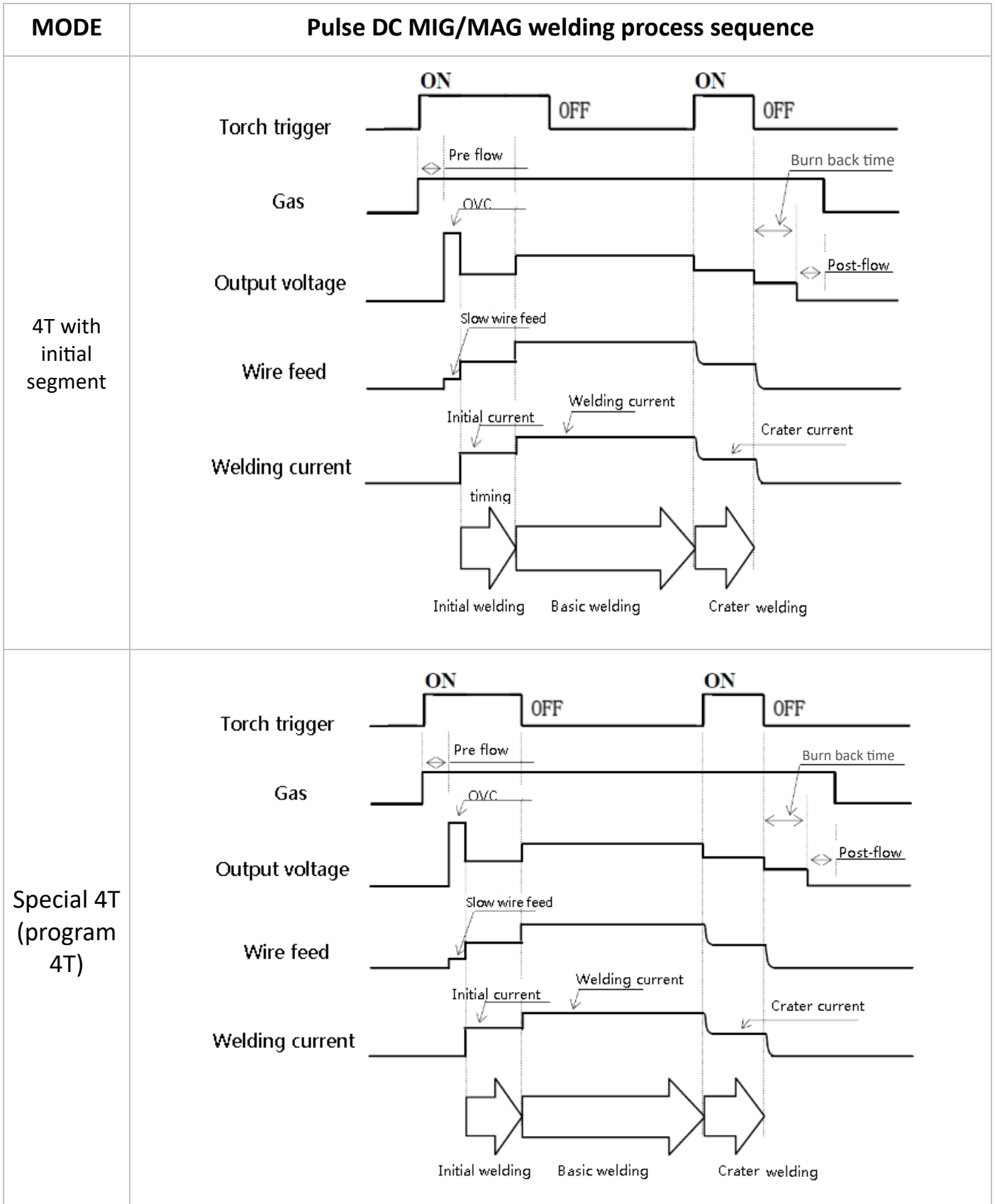

OPERATION (MIG/MAG)



Before starting any welding activity ensure that you have suitable eye protection and protective clothing. Also take the necessary steps to protect any persons within the welding area.

MIG/MAG Welding Mode - Pulse DC MIG/MAG

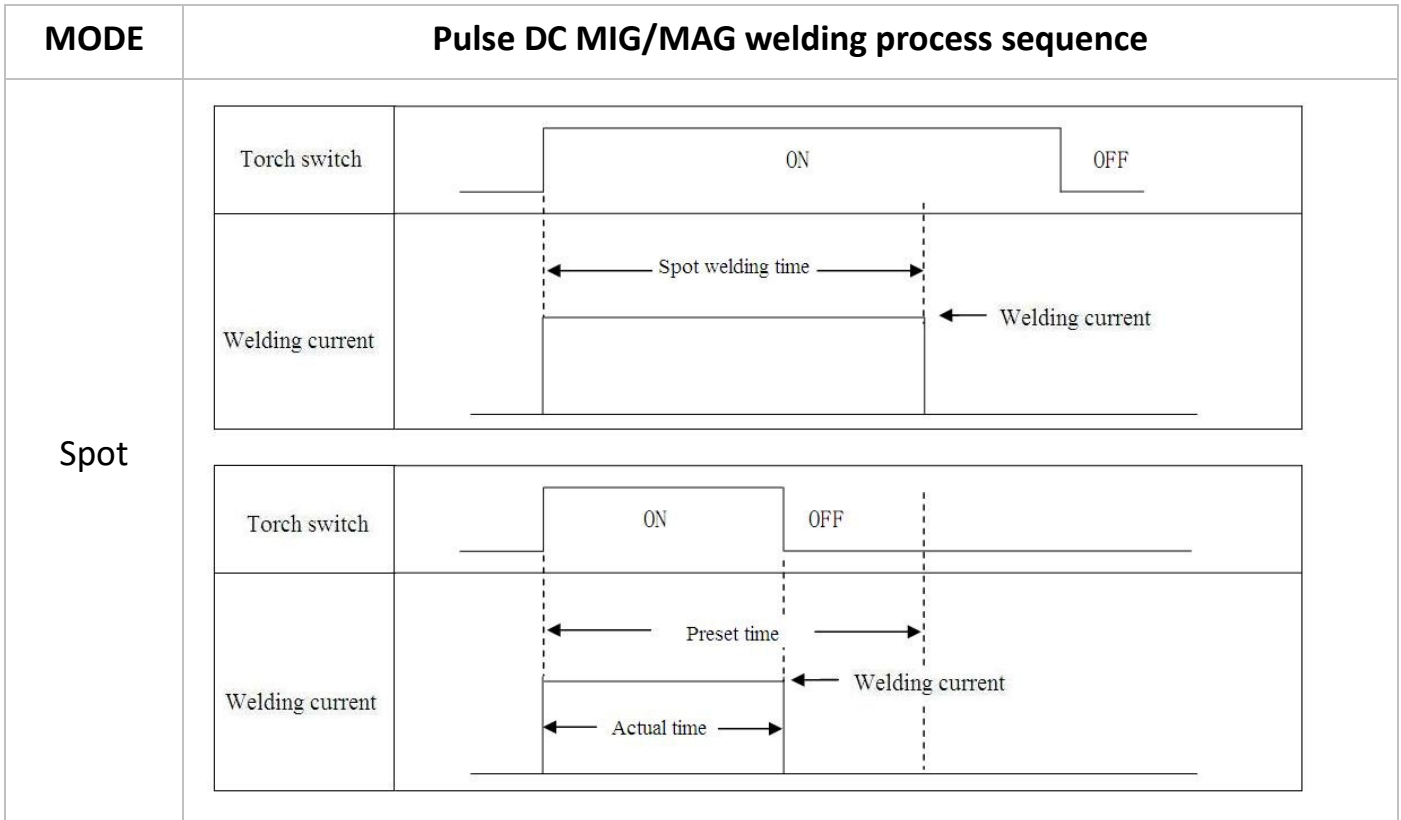

Please Note

Initial segment:

Initial segment of 2T and 4T is set for automation welding. Welding specification of this segment is -50% ~ +100% of that of process, displaying "0.5 ~ 2.0" at initial current with 0 ~ 10s.

When time is set as 0, initial segment is off. So if initial segment is needed, it is recommended to set as 1.30 with 0.5s. Initial segment of program 4T can be set freely without being affected by the process settings.

Crater phase:

It is applied to fill in the crater. This segment can be set freely but the specification is usually smaller than that of the process.

Arc force:

Its adjusting range is -10 ~ +10, taking 0 as the central value.

The welding arc becomes harder and the weld becomes narrower when adjusting in positive direction.

The welding arc becomes softer and weld becomes wider when adjusting in negative direction.

Arc force can be set respectively in the process, initial phase and crater phase.

GUIDE TO MIG/MAG WELDING



Before starting any welding activity ensure that you have suitable eye protection and protective clothing. Also take the necessary steps to protect any persons within the welding area.

MIG process description

The MIG process was first patented for the welding of aluminium in 1949 in the USA.

The process uses the heat that is generated by an electric arc formed between a bare consumable wire electrode and the work piece.

This arc is shielded by a gas to prevent oxidation of the weld.

In the MIG process an inert shielding gas is used to protect the electrode and weld pool from contamination and enhance the arc. Originally this gas was helium.

In the early 1950's the process became popular in the UK for welding aluminium using argon as the shielding gas.

Development in the use of different gases resulted in the MAG process. This is where other gases were used, for example, carbon dioxide and sometimes users refer to the process as CO2 welding. Gases such as oxygen and carbon dioxide were added and are active constituents to the inert gas to improve the welding performance. Although the MAG process is in common use today it is still referred to as MIG welding although technically this is not correct. The process began to prove itself as an alternative to stick electrode (MMA) and TIG (GTAW) offering high productivity and deposition rates. The process also helps reduce any weld defects from the increased stop/starts used in MMA. However, the welder must have a good knowledge of the system set up to achieve satisfactory welds.

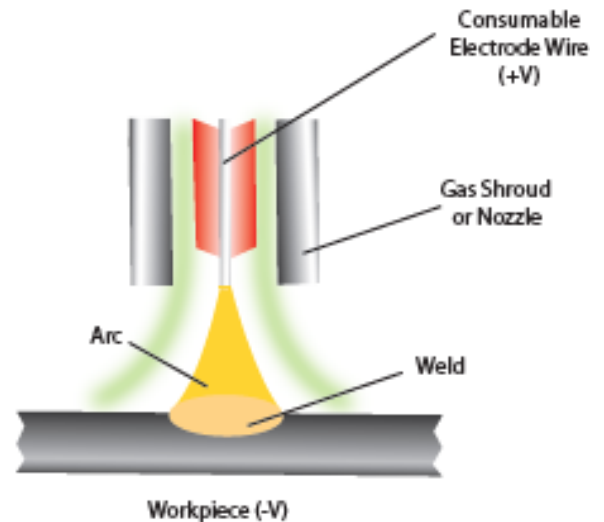

The electrode MIG gun is normally +VE and the work return is normally -VE. However, certain consumable wires sometimes require what is called reverse polarity i.e. Electrode -VE work +VE. Typical of these types of wire are cored wires used in hard facing or high deposition and gasless applications.

Typical welding ranges

Wire Diameter (mm)	DIP Transfer		Spray Transfer	
	Current (A)	Voltage (V)	Current (A)	Voltage (V)
0.6	30 ~ 80	15 ~ 18	n/a	n/a
0.8	45 ~ 180	16 ~ 21	150 ~ 250	25 ~ 33
1.0	70 ~ 180	17 ~ 22	230 ~ 300	26 ~ 35
1.2	60 ~ 200	17 ~ 22	250 ~ 400	27 ~ 35
1.6	100 ~ 280	18 ~ 22	250 ~ 500	30 ~ 40

GUIDE TO MIG/MAG WELDING



Before starting any welding activity ensure that you have suitable eye protection and protective clothing. Also take the necessary steps to protect any persons within the welding area.

Modes of Transfer

Dip or short circuit mode

In the dip or short circuit, the wire (electrode) touches the work piece and a short circuit is created. The wire will short circuit the base metal between 90 and 200 times per second. This method has the benefit of creating a small, quickly solidifying weld puddle. The deposition rates, wire speed and voltages are usually lower than other modes of transfer and the low heat input makes it a flexible mode for both thick and thin metals in all positions.

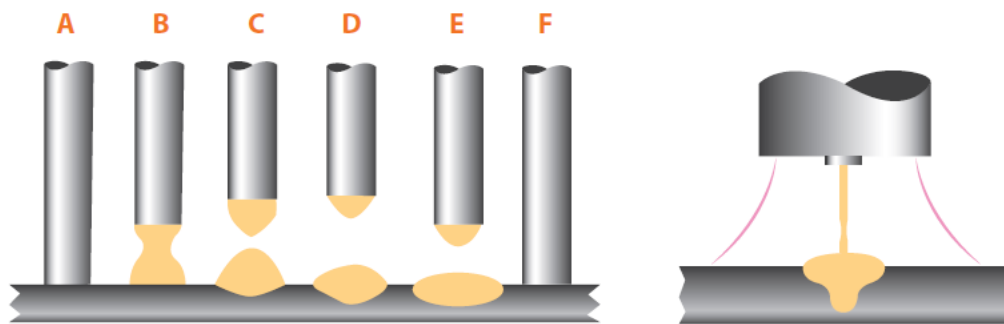

- A - Consumable wire feed to work piece and short circuit is created
- B - Wire starts to melt due to short circuit current
- C - Wire pinches off
- D - Arc length opens due to burn off
- E - Wire advances towards the work piece
- F - Wire short circuits and the process cycles again

Some of the disadvantages of this method are limited wire feed speed and hence weld deposition rates. On the thicker materials there can also be a danger of “cold lapping” occurring. This occurs when there is not enough energy in the weld puddle to fuse properly. Another disadvantage is that this mode produces an increased amount of spatter due to the short circuits especially compared to the other transfer methods. An inductance is used to control the surge in current when the wire dips into the weld pool. Modern electronic power sources can automatically set the inductance to give a smooth arc and metal transfer.

GUIDE TO MIG/MAG WELDING



Before starting any welding activity ensure that you have suitable eye protection and protective clothing. Also take the necessary steps to protect any persons within the welding area.

Modes of Transfer

Globular Transfer Mode

The globular transfer method is in effect an uncontrolled short circuit which occurs when the voltage and wire are above the dip range but too low for spray. Large irregular globules of metal are transferred

between the torch and work piece under the force of gravity.

The disadvantages of this method of transfer are that it produces a large amount of spatter as well as high heat input. In addition, globular transfer is limited to flat and horizontal fillet welds above 3mm. Lack of fusion is often common because the spatter disrupts the weld puddle.

Also, because globular transfer

uses more wire it is generally considered less efficient.

The advantages of globular transfer are that it runs at high wire feed speeds and amperages for good penetration on thick metals. Also, when weld appearance is not critical it can be used with inexpensive, CO₂ shielding gas.

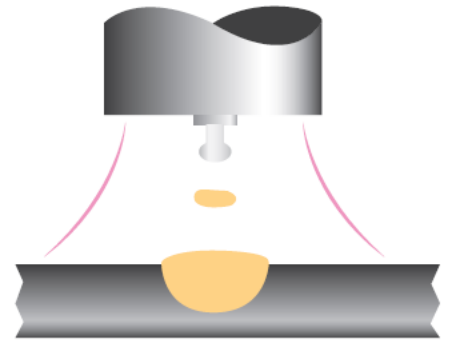

Spray Arc Mode

The Spray arc mode is used with high voltage and current. Metal is projected in the form of a fine spray of molten droplets of the electrode, propelled across the arc to the work piece by an electromagnetic force without the wire touching the weld pool.

Its advantages include high deposition rates, good penetration, strong fusion, excellent weld appearance with little spatter as no short circuits are occurring.

The disadvantages of the spray arc mode are mainly due to the high heat input which can cause problems on thinner material and the limited range of welding positions where the mode can be used.

Generally, the minimum thickness to be welded will be around 6mm.

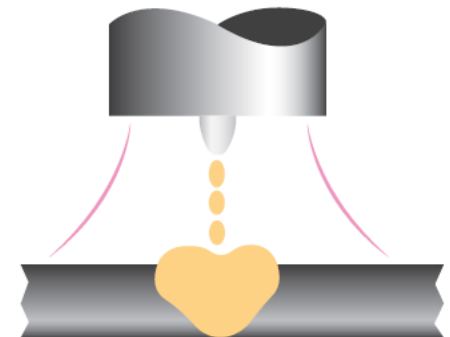

Pulsed Arc Mode

Pulsed MIG is an advanced form of welding that takes the best of all the other forms of transfer while minimizing or eliminating their disadvantages.

Unlike short circuit, pulsed MIG does not create spatter or run the risk of cold lapping. The welding positions in pulsed MIG are not limited as they are with globular or spray and its wire use is definitely more efficient. By cooling off the spray arc process, pulsed MIG is able to expand its welding range and its lower heat input does not encounter the problems on thinner materials.

In basic terms, pulsed MIG is a transfer method where material is transferred between the electrode and the weld puddle in controlled droplet form. This is achieved by controlling the electrical output of the welding machine using the latest control technologies.

The pulsed MIG process works by forming one droplet of molten metal at the end of the wire electrode per pulse. When ready the pulse of current is used to propel that one droplet across the arc and into the puddle.

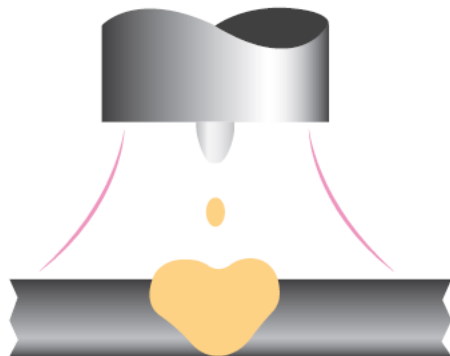

GUIDE TO MIG/MAG WELDING



Before starting any welding activity ensure that you have suitable eye protection and protective clothing. Also take the necessary steps to protect any persons within the welding area.

Notes for the welding beginner

This section is designed to give the beginner who has not yet done any welding some information to get them going. The simplest way to start is to practice by running weld beads on a piece of scrap plate. Start by using mild steel (paint free) plate of 6.0mm thick and using 0.8mm wire. Clean any grease, oil and loose scale from the plate and fix firmly to your work bench so that welding can be carried out.

Make sure that the work return clamp is secure and making good electrical contact with the mild steel plate, either directly or through the work table. For best results always clamp the work lead directly to the material being welding, otherwise a poor electrical circuit may create itself.

MIG/MAG process features and benefits

Terms used: MIG - Metal Inert Gas Welding
MAG - Metal Active Gas Welding
GMAW - Gas Metal Arc Welding

MIG welding was developed to help meet production demands of the war and post war economy which is an arc welding process in which a continuous solid wire electrode is fed through a MIG welding gun and into the weld pool, joining the two base materials together. A shielding gas is also sent through the MIG welding gun and protects the weld pool from contamination which also enhances the arc.

The MIG/MAG process can be used to weld a wide variety of materials and is normally used in the horizontal position but can be used in vertical or overhead with the correct selection of machine, wires and current. In addition, it can be used to weld at long distances from the power source subject to the correct cable sizing.

It is the dominant process used in maintenance and repair industries and is used extensively in structural and fabrication work.

Weld quality is also highly dependent on the skill of the operator and many welding problems can exist due to incorrect installation application and use.

Welding position

When welding, ensure you place yourself in a comfortable position for welding and your welding application before you begin to weld. This maybe sitting at a suitable height which often is the best way to weld ensuring you're relaxed and not tense. A relaxed posture will ensure the welding task becomes much easier.

Please ensure you always wear suitable PPE and use suitable fume extraction when welding.

Place the work so that the direction of welding is across, rather than to or from your body. The electrode holder lead should always be clear of any obstruction so that you can move your arm freely along as the electrode burns down. Some elders prefer to have the welding lead over their shoulder, this allows greater freedom of movement and can reduce the weight from your hand.

Always inspect your welding equipment, welding cables and electrode holder before each use to ensure it's not faulty or worn as you may be at risk of an electric shock.

GUIDE TO MIG/MAG WELDING



Before starting any welding activity ensure that you have suitable eye protection and protective clothing. Also take the necessary steps to protect any persons within the welding area.

Inductance

When MIG/MAG welding in the dip transfer mode the welding wire electrode touches the work piece/weld pool and this results in a short circuit. When this short circuit occurs the arc voltage will fall to nearly zero. This change in the arc voltage will cause a change in the welding circuit. The fall in voltage will cause a rise in the welding current. The size of the current rise is dependent upon the welding characteristic of the power source.

Should the power source respond immediately then the current in the circuit would rise to a very high value. The rapid increase in current would cause the short circuited welding wire to melt similar to an explosion creating a large amount of molten weld spatter.

By adding inductance to the weld circuit this will slow down the rate of current rise. It works by creating a magnetic field which opposes the welding current in the short circuit thereby slowing the rate of rise. If the inductance is increased it will cause an increase in arc time and reduction in the dip frequency, this will help reduce spatter.

Depending on the welding parameters there will be an optimum inductance setting for the best welding conditions. If the inductance is too low then there will be excessive spatter. If the inductance is too high the current will not rise high enough and the wire will stab the weld pool with insufficient heat. The modern technology welding power sources often have the ability to provide the correct inductance to provide excellent weld characteristics. Many have a variable inductance control to give precise control.

Burn Back

In the event that the welder was to stop welding and all functions of the machine stopped simultaneously then the consumable filler wire would in all likelihood freeze in the weld pool.

In order to avoid this happening the burn back feature is present on most machines.

This facility may be built in or an adjustable control. It will allow the power and gas shield to be maintained on the consumable filler wire when it has stopped feeding thereby burning clear of the weld. In some equipment the burn back is preset within the control circuits others offer an external variable control feature to adjust the time of delay.

Other Controls

Other common control features are latching or 2T/4T where the welding can either in 2T mode press the torch trigger to weld and release to stop or in 4T press and release the torch trigger to start, weld without holding the trigger on and stop by pressing and releasing the trigger again. This is particularly useful when welding long weld runs.

Crater fill controls are available on many machines. This allows the crater at the end to be filled helping eliminate welding defects.

A spot welding timer will allow the time of the weld to be set and after the time has expired the operator will have to release the torch switch to restart the weld.

GUIDE TO MIG/MAG WELDING



Before starting any welding activity ensure that you have suitable eye protection and protective clothing. Also take the necessary steps to protect any persons within the welding area.

SYNERGIC AND STANDARD MODES

Synergic Mode

When a welder is referred to as synergic it means that when a single setting is adjusted (*voltage, or material thickness, most commonly*) the other settings (*current, or wire speed*) also change. There are current and voltage settings for any wire type, wire diameter, shielding gas. The same current have different wire feed speed, workpiece thickness, and synergic voltage for different wire diameters. After setting the current or wire feed speed, workpiece thickness, the system will have an auto match for welding voltage and other parameters.

After choosing “synergic”, the machine panel’s left display will show preset current(or wire feed speed, or workpiece thickness dependent on the parameter selected). The right display will show the preset voltage. The wire feeder control panel left display will show preset current and right display will show preset arc length. Both wire feed unit controls can both set current and voltage. Standard arc length is “0”; adjustment is based on the synergic voltage plus or minus 3.0V.

Standard Mode:

Current or wire feed speed, workpiece thickness adjustment has no relation with voltage adjustment and other parameters. In this modes all required parameters are to be set as separate settings. Please see wire speed and voltage setting above.

Some quick reference handy tips for the MIG/MAG welding process are:

- When welding, try to use an electrode stick out (the distance between the weld and the contact tip) of around 6-8mm
- When welding thin materials try and use smaller MIG wire diameters and for thicker materials use thicker wires
- Make sure you select the correct MIG wire type for the material to be welded
- Ensure the MIG welding gun has the correct sized contact tip and type of liner
- Always ensure you have the correct size drive rolls and torch liner for the wire size selected
- Select the correct gas to achieve the correct weld characteristics and finish
- For optimum control of the weld keep the wire at the leading edge of the weld pool
- Before commencing welding, ensure a comfortable and stable position
- Try to keep the welding torch as straight as possible when welding to ensure the best feed
- Carry out daily housekeeping on the condition of the welding torch and drive rolls
- Keep any consumables clean and dry to avoid contamination such as oxidation and damp

GUIDE TO MIG/MAG WELDING



Before starting any welding activity ensure that you have suitable eye protection and protective clothing. Also take the necessary steps to protect any persons within the welding area.

MIG/MAG system checks

Shielding gas nozzle

This nozzle must be periodically cleaned to remove weld spatter. Replace if distorted or squashed.

Contact Tip

Only a good contact between this contact tip and the wire can ensure a stable arc and optimum current output; you must therefore observe the following precautions:

- The contact tip hole must be kept free of grime and oxidation (rust).
- Weld spatter sticks more easily after long welding sessions, blocking the wire flow, the tip must therefore be cleaned often and replaced if necessary.
- The contact tip must always be firmly screwed onto the torch body. The thermal cycles to which the torch is subjected can cause it to loosen, thus heating the torch body and tip and causing the wire to advance unevenly.

MIG Torch Wire Liner

This is an important part that must be checked often because the wire may deposit copper dust or tiny shavings. Clean it periodically along with the gas lines using dry compressed air. The liners are subjected to constant wear and tear and therefore must be replaced after a certain amount of time.

Wire Drive System

Periodically clean the set of feeder rollers to remove any rust or metal residue left by the coils. You must periodically check the entire wire feeder group: feed arms, wire guide rollers, liner and contact tip.

MIG Set-Up Guide

MIG WELDING GUIDE

Please Note: This information is intended to act as a guide only

Material	Wire Type	Polarity	Shielding Gas (20-30 CFH Flow Rate)	Wire Dia.	0.5mm	0.6mm	0.8mm	1.0mm	1.2mm	1.6mm	3.0mm	4.5mm	6.0mm	6.0mm	8.0mm	10.0mm		
Steel	Solid Wire ER70S-6	DCEP	C25	0.6	15.5/3.2	15.5/3.6	16/4.3	16.5/5.6	17/6.4	17.5/7.8	18/9.7	18.5/10.5	-	-	-	-		
				0.8	15.5/2.3	15.5/2.4	16/2.8	16.5/3.8	17/5.1	17.5/5.7	18.5/6.4	19/7	19.5/7.9	19.5/7.9	20/8.9	21.5/10.5		
				1.0	15.5/1.8	15.5/2	16/2	16.5/2.8	17/3.6	17.5/4.2	18.5/4.5	19.5/5.1	19.5/7.9	19.5/7.9	20/5.7	20/5.7	21/7.6	
				0.6	16.5/3.2	16.5/3.6	17/4.3	18/5.6	18.5/6.4	19/8.6	19.5/9.9	20/10.5	20/10.5	20/10.5	-	-	-	-
				0.8	16.5/2.3	16.5/2.4	17/2.8	18/3.8	18.5/5.1	19/5.7	19.5/6.4	20/5.7	20/5.7	22/7.9	22/7.9	22/7.9	23.5/8.6	25/9.2
				1.0	16.5/1.8	16.5/2	17/2	18/2.8	18.5/3.6	20/4.2	21/4.1	22/5.5	22/6	22/6	22/6	22/6	23.5/7	24.5/8
	Flux-Cored E71T-11	DCEN	-	0.8	-	-	-	14/1.8	14.5/3.1	14.5/1.8	16/3.6	17.5/5.1	18.5/7.6	-	-	20.5/9.5	21/10.5	
				1.0	-	-	-	-	15/2.3	17/3.6	18/4.1	18/4.1	-	-	20.5/6.6	21/7.1		
				0.6	-	18/4.1	18.5/4.6	19/5.6	20/8.3	21.5/10.2	-	-	-	-	-	-	-	
Stainless Steel	DCEP	Tri-Mix	0.8	-	18/2.7	18.5/3.0	19/3.8	19.5/4.1	19.5/4.1	20/5.1	21.5/6.6	22/8.1	22/9.2	22/9.2	22.5/9.6	23/10.2		
			1.0	-	18/2	18.5/2.2	18.5/2.8	19/3.1	19/3.1	21/4.8	21/4.8	22/6.1	22/6.1	22/6.1	22/6.1	22.5/6.6	23/7	
Aluminium	ER4043	DCEP	Argon	0.8	-	-	-	13/7.6	14/8.1	14.5/10.2	20/8.9	21/9.3	-	-	-	-		
				1.0	-	-	-	14.5/6.1	16/7.1	17/8.6	20/7.6	22/9.2	-	-	23/9.7	-	-	

MIG WELDING PROBLEMS



Before starting any welding activity ensure that you have suitable eye protection and protective clothing. Also take the necessary steps to protect any persons within the welding area.

MIG welding defects and prevention methods

<u>Defect</u>	<u>Possible cause</u>	<u>Action</u>
Porosity (within or outside the bead)	Poor material Insufficient shield gas flow Gas flow too low/high Leaking hoses Faulty gas valve Working in open area with drafts	Check the material is clean Check hoses and MIG torch for blockages Check the regulator setting or that it is not frozen due to a high flow Check all hoses for leaks Call a service engineer Put screens up around the weld area
Poor or inconsistent wire feed	Incorrect pressure on wire drive causing burn back to contact tip or bird nesting at the feed roll Damage to torch liner Welding wire contaminated or rusty Worn welding tip	Readjust the upper feed pressure Increase the pressure to eliminate burn back to tip Decrease pressure to eliminate bird nesting Replace torch liner Replace wire Check and replace welding tip
No operation when the torch switch is operated	Torch switch faulty Fuse blown Faulty PCB inside the equipment	Check the torch switch continuity and replace if faulty Check fuses and replace if necessary Call a service engineer
Low output current	Loose or defective work clamp Loose cable plug Power source faulty	Tighten/replace clamp Re-fix plug Call a service engineer
No operation	No operation and mains lamp not lit Faulty power source	Check mains fuse and replace if required Call a service engineer
Excessive spatter	Wire feed speed too high or welding voltage too low	Reset the parameters according to the weld to be made
Excessive penetration, the weld metal is below the surface level of the material and hangs below	Heat input too high Poor weld technique	Reduce the amperage or use a smaller electrode and lower amperage Use correct welding travel speed

MIG WELDING PROBLEMS



Before starting any welding activity ensure that you have suitable eye protection and protective clothing. Also take the necessary steps to protect any persons within the welding area.

MIG welding defects and prevention methods

<u>Defect</u>	<u>Possible cause</u>	<u>Action</u>
Burning through – Holes within the material where no weld exists	Heat input too high	Use lower amperage or smaller electrode Use correct welding travel speed
Poor fusion – Failing of weld material to fuse either with the material to be welded or previous weld beads	Insufficient heat level Poor welding technique Work piece dirty	Increase the amperage or increase the electrode size and amperage Joint design must allow for full access to the root of the weld Alter welding technique to ensure penetration such as weaving, arc positioning or stringer bead technique Remove all contaminant from the material i.e. oil, grease, rust, moisture prior to welding
Irregular weld bead and shape	Incorrect voltage/wire feed settings, if the bead is convex then the voltage is too low and if it is concave then the voltage is too high Insufficient or excessive heat input Wire is wandering Incorrect shielding gas	Adjust voltage and/or wire feed speed Adjust the wire feed speed dial or the voltage control Replace contact tip Check and change the shielding gas as required
Your weld is cracking	The weld beads too small Weld penetration narrow and deep Excessive voltage Weld/material cooling rate too fast	Try decreasing the travel speed Try reducing the wire feed speed current and voltage or increase MIG torch travel speed Decrease voltage control dial Slow the cooling rate by preheating part to be welded or cool slowly
The welding arc does not have a crisp sound that short arc exhibits when the wire feed speed or voltage are adjusted correctly	The MIG torch may have been connected to the wrong output voltage polarity on the front panel	Ensure that the MIG torch polarity lead is connected to the positive (+) welding terminal for solid wires and gas shielded flux cored wires

MIG TORCH SPARE PARTS LIST

JM-500P Water Cooled Machine Package

Water Cooled MIG Torch - Model: T501

Rating 500A Co2 / 450A Mixed Gases @ 100% Duty Cycle EN60974-7 Wire Size 1.0mm to 1.6mm



Torch Packages

T501-3 T501-4 T501-5

3 metre 4 metre 5 metre

*Euro Fitting and Bladeswitch

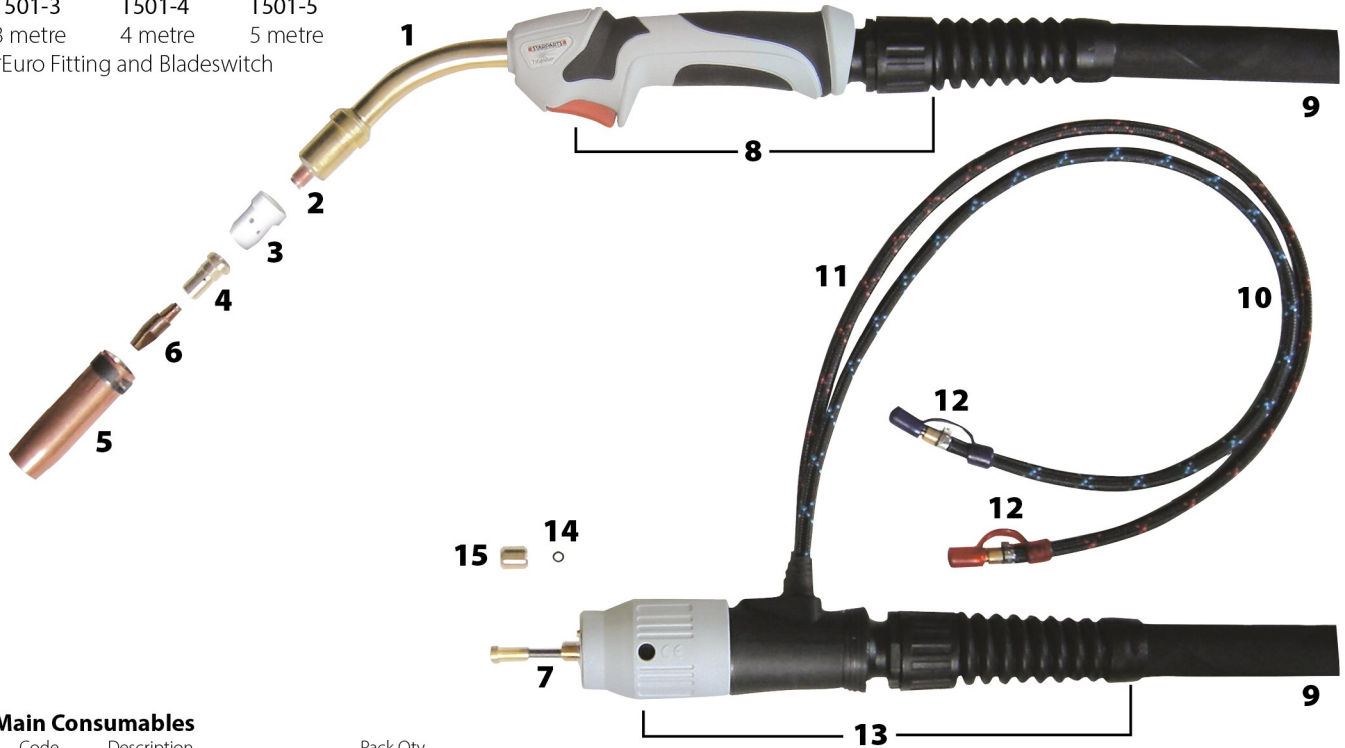

Main Consumables

Code	Description	Pack Qty
1	SP5054 Swan Neck	1
2	SP4055 Insulating Washer	10
3	SP3858 Diffuser Black	5
	SP3858W Diffuser White	5
	SP3858C Diffuser Ceramic	5
4	SP4081 Tip Adaptor Short M8 Tips	5
	SP4082* Tip Adaptor M6 Tips	5
	SP4083 Tip Adaptor Long M8 Tips	5
5	SP2670 Nozzle Conical	5
	SP2671 Nozzle Cylindrical	5
	SP2672 Nozzle Tapered	5

Contact Tips (ECU M8 x 30mm)

6	SP3810 1.0mm Steel / 0.8mm Alum Wire	25
	SP3812 1.2mm Steel / 1.0mm Alum Wire	25
	SP3814 1.4mm Alum / 1.2mm Alum Wire	25
	SP3816 1.6mm Steel Wire	25

* For specifically marked ALU Tips add 'A' after the part number
eg: SP3810A

Contact Tips (CuCrZr M8 x 30mm)

	SP4008 0.8mm Steel / 0.6mm Alum Wire	25
	SP4010 1.0mm Steel / 0.8mm Alum Wire	25
	SP4012 1.2mm Steel / 1.0mm Alum Wire	25
	SP4014 1.4mm Alum Wire	25
	SP4016 1.6mm Steel Wire	25

Liners (Steel)

Code	Description	Pack Qty
7	SP3531 0.8 - 1.0mm x 3m	1
	SP3541 0.8 - 1.0mm x 4m	1
	SP3551 0.8 - 1.0mm x 5m	1
	SP3532 1.0mm-1.2mm x 3m	1
	SP3542 1.0mm-1.2mm x 4m	1
	SP3552 1.0mm-1.2mm x 5m	1
	SP3536 1.6mm x 3m	1
	SP3546 1.6mm x 4m	1
	SP3556 1.6mm x 5m	1

Liners (PTFE)

	SP2432T 1.0 - 1.2mm x 3m	1
	SP2442T 1.0 - 1.2mm x 4m	1
	SP2452T 1.0 - 1.2mm x 5m	1
	SP2436T 1.6mm x 3m	1
	SP2446T 1.6mm x 4m	1
	SP2456T 1.6mm x 5m	1
	SP1511 Liner Collet 0.6mm-1.2mm	5
	SP1511-47 Liner Collet 1.6mm	5
	SP1517 Liner 'O' Ring	10

Secondary Consumables

Code	Description	Pack Qty
8	SP1626 Bladeswitch Handle c/w Cable Support	1
9	SP3503 Complete Cable Assy 3m	1
	SP3504 Complete Cable Assy 4m	1
	SP3505 Complete Cable Assy 5m	1
	SP3535 Power Cable Assy 3m	1
	SP3545 Power Cable Assy 4m	1
	SP3555 Power Cable Assy 5m	1
	SP3537 Outer Liner Assy 3m	1
	SP3547 Outer Liner Assy 4m	1
	SP3557 Outer Liner Assy 5m	1
	SP3530 Gas Hose 3m	1
	SP3540 Gas Hose 4m	1
	SP3550 Gas Hose 5m	1
	SP3533 Trigger Cable Per m	1
	SP3513 Canvas Cover Per m	1
10	SP3523 Water Inlet Hose Per m	1
11	SP3515 Water Outlet Hose 0.5m	1
12	SP3526 Hose Nipple	10
13	SP8004 Euro Connector Kit c/w Cable Support 1	1
14	SP1596 Gun Plug 'O' Ring	10
15	SP1597 Liner Retaining Nut	5

* For 6mm Threaded Tips Use SP24 / SP25 Series
See Page 192 Item No. 5

MIG TORCH SPARE PARTS LIST

JM-500P Water Cooled Machine Package

MIG Welding Torch Water Cooled - HC550

Hard Core HC550 Rating 550A Co2 / 450A Mixed Gases @ 80% Duty Cycle EN60974-7 Wire Size 0.8mm to 2.8mm

Please Note:

From December 2023 the manufacture started the process of changing the supplied MIG torch from the Titanium T501 to the Hard Core HC550. For this reason we have enclosed both MIG torch spare lists, please check which MIG torch your package was supplied with before ordering any consumable spares.

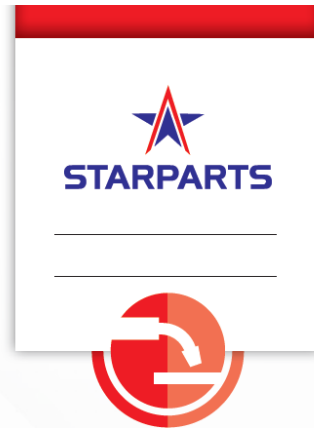

HARD CORE 550A TORCH WATER COOLED

MIG Welding Torch Model: HC550

Rating 550A Co2/450A Mixed Gases @ 80% Duty Cycle EN60974-7 Wire Sizes 0.8-2.8mm

Torch Packages		
HC550-3E	HC550-4E	HC550-5E
3 metre	4 metre	5 metre
*Euro Fitting and Bladeswitch		

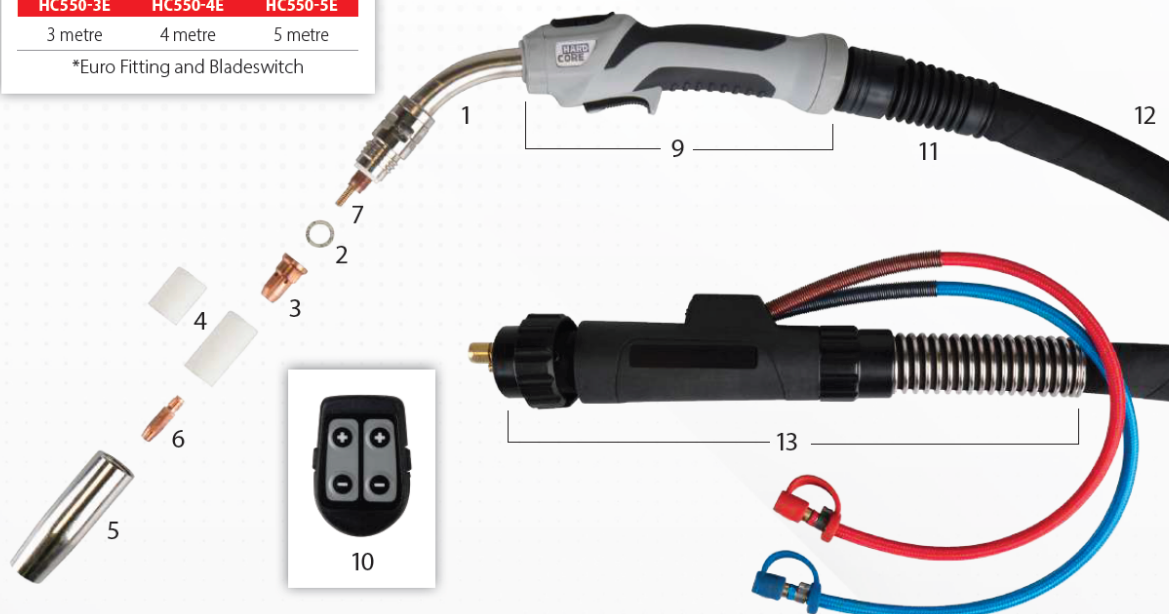

MAIN CONSUMABLES

Code	Description	Pack Qty
1	HC5551 Swan Neck 45°	1
2	HC5502 Neck Washer	10
3	HC5503 Gas Diffuser M8	5
4	HC5504S Nozzle Ins Short 26mm (Tapered Nozzle)	5
	HC5504L Nozzle Ins Long 30.5mm (Conical/Cylindrical)	5
5	HC5505 Conical Nozzle	5
	HC5506 Cylindrical Nozzle	5
	HC5507 Tapered Nozzle	5

CONTACT TIPS M8 X 33MM ROUND CUCRZR

6	HC4008 0.8mm Steel	25
	HC4010 1.0mm Steel/0.8mm Alu	25
	HC4012 1.2mm Steel/1.0mm Alu	25
	HC4014 1.4mm Steel/1.2mm Alu	25
	HC4016 1.6mm Steel/1.4mm alu	25
	HC4020 2.0mm Steel/1.8mm Alu	25
	HC4024 2.4mm Steel/2.0mm Alu	25
	HC4028 2.8mm Steel/2.4mm Alu	25

LINERS (STEEL)

7	HC3300 0.8-1.2mm 3M Blue	1
	HC3400 0.8-1.2mm 4M Blue	1
	HC3500 0.8-1.2mm 5M Blue	1
	HC3301 1.2-1.4mm 3M Grey	1
	HC3401 1.2-1.4mm 4M Grey	1
	HC3501 1.2-1.4mm 5M Grey	1
	HC3302 1.4-2.0mm 3M Red	1
	HC3402 1.4-2.0mm 4M Red	1
	HC3502 1.4-2.0mm 5M Red	1
	HC3303 2.0-3.2mm 3M Yellow	1
	HC3403 2.0-3.2mm 4M Yellow	1
	HC3503 2.0-3.2mm 5M Yellow	1

LINERS (ALUMINIUM)

Code	Description	Pack Qty
8	HC4300 0.8-1.0mm 3M Black	1
	HC4400 0.8-1.0mm 4M Black	1
	HC4500 0.8-1.0mm 5M Black	1
	HC4301 1.0-1.2mm 3M Blue	1
	HC4401 1.0-1.2mm 4M Blue	1
	HC4501 1.0-1.2mm 5M Blue	1
	HC4302 1.6mm 3M Red	1
	HC4402 1.6mm 4M Red	1
	HC4502 1.6mm 5M Red	1
	HC4303 2.0-3.2mm 3M Yellow	1
	HC4403 2.0-3.2mm 4M Yellow	1
	HC4503 2.0-3.2mm 5M Yellow	1

SECONDARY CONSUMABLES

9	HC3017 Torch Handle Kit	1
10	HC4BCM 4 Button Control Module	1
11	HC5018 Cable Support	1
12	HC5019 Power Cable 3M	1
	HC5020 Power Cable 4M	1
	HC5021 Power Cable 5M	1
	HC5022 Water Hose 3M	1
	HC5023 Water Hose 4M	1
	HC5024 Water Hose 5M	1
	HC5025 Outer Liner 3M	1
	HC5026 Outer Liner 4M	1
	HC5027 Outer Liner 5M	1
13	HC5028 Torch Back End Kit	1

* Torch Handle Kit Comprises Handle Sheets, Trigger, Front & Rear Lock Nuts, Blanking Plate
 * Torch Back End Kit Comprises Gun Plug Body, Gun Plug Housing, Gun Plug Nut, Locking Nut, Red & Blue Hoses

MAINTENANCE



The following operation requires sufficient professional knowledge on electric aspects and comprehensive safety knowledge. Make sure the input cable of the machine is disconnected from the electricity supply and wait for 5 minutes before removing the machine covers.

In order to guarantee that the arc welding machine works efficiently and in safety, it must be maintained regularly. Operators should understand the maintenance methods and means of arc welding machine operation. This guide should enable customers to carry out simple examination and safeguarding by oneself, try to reduce the fault rate and repair times of the arc welding machine, so as to lengthen service life of the MIG welding machine.

<u>Period</u>	<u>Maintenance item</u>
Daily examination	<ul style="list-style-type: none"> • Check the condition of the machine, mains cables, welding cables and connections • Check for any warnings LEDs and machine operation
Monthly examination	<ul style="list-style-type: none"> • Disconnect from the mains supply and wait for at least 5 minutes before removing the cover • Check internal connections and tighten if required • Clean the inside of the machine with a soft brush and vacuum cleaner • Take care not to remove any cables or cause damage to components • Ensure that ventilation grills are clear • Carefully replace the covers and test the unit <p>This work should be carried out by a suitably qualified competent person</p>
Yearly examination	<ul style="list-style-type: none"> • Carry out an annual service to include safety check in accordance with the manufacturers standard (EN 60974-1) <p>This work should be carried out by a suitably qualified competent person</p>

* Ensure the power is disconnected before working on the machine.

* Always wait 5 minutes after power switch off before opening the case.

SERVICE SCHEDULE RECORD

Date	Type of service and work carried out	Serviced by	Due date for next check

TROUBLESHOOTING



The following operation requires sufficient professional knowledge on electric aspects and comprehensive safety knowledge. Make sure the input cable of the machine is disconnected from the electricity supply and wait for 5 minutes before removing the machine covers.

Before arc welding machines are dispatched from the factory, they have already been checked thoroughly. The machine should not be tampered with or altered. Maintenance must be carried out carefully. If any wire becomes loose or is misplaced, it maybe potentially dangerous to the user!

- * Only professional maintenance personnel should repair the machine!
- * Ensure the power is disconnected before working on the machine.
- * Always wait 5 minutes after power switch off before removing the panels.

<u>Description of fault</u>	<u>Possible cause</u>
The digital display is OFF and the fan is not functioning	The primary supply voltage has not been switched ON or input fuse has blown
	The welding power source input switch is switched OFF
	Loose connections internally
The digital display is ON but the fan is not running	The machine needs to have an arc struck to start the fan. The machine fan blades may be jammed The machine fan may not be functional Check the wiring and the supply voltage to the fan
Wire feed motor does not rotate when the MIG torch trigger switch is depressed	Check wire feed speed, to ensure its not set to zero
	Check supply to wire feed motor
	Possible motor PCB fault
Output current reduces when welding	Poor work lead connection to the work piece
TIG electrode melts when arc is struck	TIG torch is connected to the (+) VE terminal
No gas flow when the MIG torch trigger switch is depressed	Empty gas cylinder Gas regulator is turned off Gas hose is blocked or cut Torch trigger switch lead is disconnected or switch/lead is faulty
Difficult to ignite the arc	The welding voltage is too low or the wire feed speed is set too high
The electrode holder becomes very hot	The rated current of the electrode holder is smaller than its actual working current, replace it with a higher rated current capacity
Excessive spatter in MMA welding	The output polarity connection is incorrect, exchange the polarity
Other malfunction	Contact your supplier
Overheat error code lights up	Let the machine cool, it will automatically start again Insufficient cooling air Cooling fan is not running
Wire continues to feed through when the MIG torch switch is released	The trigger mode switch is set to 4T rather than 2T Faulty MIG torch switch
No coolant flow	The machine needs an arc to start the cooler unit. Strike an arc and check again

TROUBLESHOOTING



The following operation requires sufficient professional knowledge on electric aspects and comprehensive safety knowledge. Make sure the input cable of the machine is disconnected from the electricity supply and wait for 5 minutes before removing the machine covers.

- ⇒ Ensure the power is disconnected before working on the machine.
- ⇒ Always wait 5 minutes after power switch off before opening the case.

Description of fault	Possible cause	Possible Solution
The fan does not work or works abnormally during welding	The three-phase mains power cable is not well connected.	Reconnect the three-phase power cable or have an electrician check the mains supply
	Input phase failure	Solve the phase failure problem, have an electrician check the mains supply
	The input mains voltage is low And under machine tolerance level	Wait until the mains voltage Recovers or have an electrician check the mains supply
There is no no-load voltage output, the alarm indicator illuminates, the display window displays “Err 000”, and the buzzer beeps continuously	Overcurrent or damage of power parts	Restart the machine. If overcurrent still exists, contact your supplier
There is no no-load voltage output, the alarm indicator illuminates, the display window displays “Err 001”, and the buzzer beeps	The mains voltage is overly low	Welding can be carried out after the mains voltage recovers
	The mains voltage is overly high	Disconnect the machine with the mains power supply, and reconnect it after the mains voltage recovers
	Auxiliary power fails	Replace the fault circuit board of the auxiliary power
After turning on the welding machine and feeding gas, the wire feeder feeds wire, but there is no current out-put, and the alarm indicator does not illuminate	The earth cable is unconnected to or not well connected to the workpiece.	Reconnect cable or have it checked, have an electrician check the system
	The control cable of the wire feeder is unconnected or not well connected.	Reconnect cable or have it checked, have an electrician check the system
	The wire feeder or welding torch has failed.	Repair the wire feeder or welding torch, have an electrician check the system
After turning on the welding machine and feeding gas, there is current output, but the wire feeder does not feed wire	The control cable of the wire feeder is broken	Repair or replace the control cable of the wire feeder
	The wire feeder is clogged	Check and clean drive system
	The wire feeder fails	Have an electrician check the wire feed unit and control cable
	The control PCB or wire feeding power PCB inside the welding machine fails	Have an electrician check the wire feed unit and PCB

ERROR CODES



The following operation requires sufficient professional knowledge on electric aspects and comprehensive safety knowledge. Make sure the input cable of the machine is disconnected from the electricity supply and wait for 5 minutes before removing the machine covers.

- ⇒ Ensure the power is disconnected before working on the machine.
- ⇒ Always wait 5 minutes after power switch off before opening the case.

In the case of a machine malfunction an error code will be displayed via the digital displays.

The left display shows “Err” and the right display shows “---” (error code number)

The below are a list of the error code meanings and welding operation will not possible.

Error code	Possible cause	Possible solution
010	Over current or failed power components	Restart the machine; if over-current error still exists, please contact your dealer
031	Low mains supply voltage Failure on the auxiliary power supply	The machine can resume to work when the mains supply voltage is back to normal. Replace the control board or auxiliary transformer
060	Overheat protection (thermo switch)	The machine should auto recover after machine has cooled down. Do not switch off the machine
061	Overheat protection (temperature probe)	The machine should auto recover after machine has cooled down. Do not switch off the machine
071	Failure on coolant flow	Please check if there is not enough coolant in the tank and check if water flow is flowing. Check for airlocks
070	Water cooler over-heat The radiator is not well connected to the welder	The radiator has over-heated. Stop welding until the radiator is cooled off and problem is solved. Please check the cooler is plugged in correctly. Turn off the machine or there might be a danger of electric shock hazard.
052	Wire feeder communication failure	Check all leads and connections. If the error still exists, please contact your dealer

SUBMENU FUNCTIONS



Please be careful when accessing the submenu internal parameters that are applied to factory calibration and adjustment for special applications or requirements.

Adjusting factory set parameters may result with machine operational failure and should only be carried out by a skilled Jasic trained technician.

JM-500P Submenu Parameters

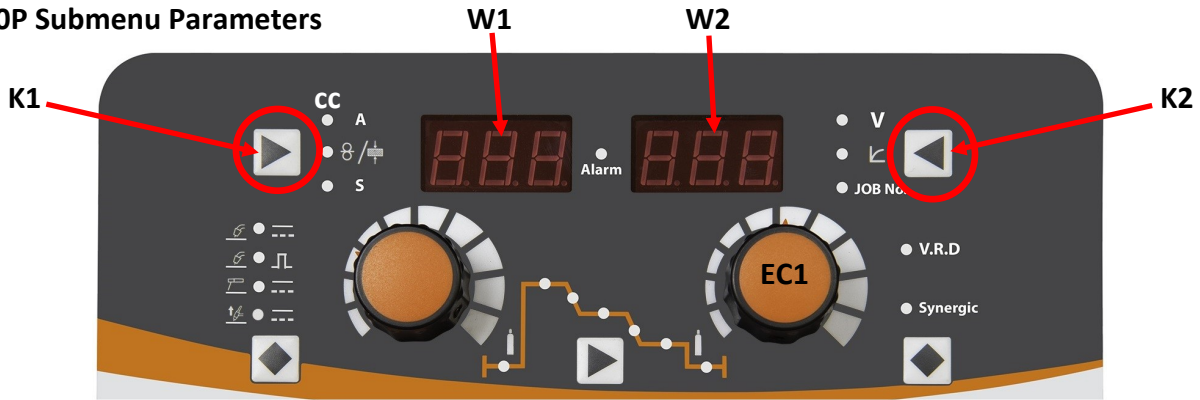

Entering Submenu Mode

1. Start with the machines mains power in the OFF position.
2. Press and hold the button K2 then turn the machine power 'ON' until the left digital meters W1 shows '001' and digital meter W2 shows 'CAL' then release the button K2. You are now within the submenu.
3. Press the button K1 to switch between menu No's (as noted below) noted in display W1.
4. Rotate the right control dial EC1 to adjust the selected parameter noted in display W2.
5. Pressing K2 will then safe and exit the submenu mode.

Menu No.	Parameter definition	Parameter value	Remark
P1	Actual current calibration	Please contact your local Jasic service center	 Please do not change!
P2	Display current calibration		
P3	Display voltage calibration		
P4	Actual voltage calibration		
P5	Wire feed speed or material thickness displayed. Factory preset is 0 (wire feed speed).	0 = wire feed speed 1 = material thickness	
P6	Metric unit and English unit. Factory preset is 0 (metric)	0 = Metric unit 1 = English unit	
P7	Temperature of inverter - The digital display meter will show the temperature	A facility for the local Jasic service center to check accuracy of the inverter temperature	
P8	High speed (22m/min) calibration of wire feed speed	Please contact your local Jasic service center	 Please do not change!
P9	Low speed (2m/min) calibration of wire feed speed		
P11	VRD activation switch Factory preset is 1 (VRD ON)	0 = VRD OFF 1 = VRD ON	
P12	Water cooler function 0 = turns OFF the cooling pump its related functions 1 = turns ON the cooling system and its related functions	Factory preset is 1 Select 0 if using a air cooled MIG torch Select 1 if using a water cooled MIG torch	
P15	Welder overheating protection point setting	Protective temperature setting around IGBT	 Please do not change!
P22	Speed adjustment	It is defaulted as 1.00, which can be adjusted to 0.5 ~ 1.5 times of current speed.	
P24	Slow wire feeding adjustment	0 ~ 10.0 plus slow feeding speed.	
P23	Factory reset (of stored jobs and their parameters)	0: unchanged; 1: factory reset	

Please Note: Depending on installed firmware and age of machine, some of the factory presets may differ to what is shown above.

WEEE disposal

The equipment is manufactured with materials which do not contain any toxic or poisonous materials dangerous to the operator.

When the equipment is scrapped, it should be dismantled separating components according to the type of materials.

Do not dispose of the equipment with normal waste. The European Directive 2002/96/EC and United Kingdom's Directive The Waste Electrical and Electronic Equipment (WEEE) regulations 2013 states that electrical equipment that has reached its end of life must be collected separately and returned to an environmentally compatible recycling facility.

Jasic has a relevant recycling system which is compliant and registered in the UK with the environment agency. Our registration reference is WEEMM3813AA.

In order to comply with WEEE regulations outside the UK you should contact your supplier.

RoHS Compliance Declaration

We herewith confirm, that the above mentioned product does not contain any of the restricted substances as listed in EU Directive 2011/65/EU and the UK directive ROHS Regulations 2012 in concentrations above the limits as specified therein.

UKCA Declaration of Conformity

The manufacturer, or its legal representative Wilkinson Star Limited, declares that the equipment described below is designed and produced according to following UK legislation:

- Electrical equipment safety 2016
- Electromagnetic compatibility (EMC) regulations 2016
- The restrictions of the use of certain hazardous substances in electrical and electronic equipment regulations 2012

And inspected according to following designated standards:

- EN 60 974-1:2018+A1:2019
- EN 60 974-10:2014+A1:2015

Any alteration or change to these machines by any unauthorized person makes this declaration invalid.

Model:

JM-500P

Authorised Representative:

Wilkinson Star Limited
Shield Drive
Wardley Industrial Estate
Worsley
Manchester
M28 2WD

Disclaimer:

Please note that this confirmation is given to the best of our present knowledge and belief. Nothing herein represents and/or may be interpreted as warranty within the meaning of the applicable warranty law.

EC Declaration of Conformity

EC DECLARATION OF CONFORMITY

The manufacturer, or its legal representative **Wilkinson Star Limited**, declares that the equipment described below is designed and produced according to following EU Directives:

- Low Voltage Directive (LVD), No.: 2014/35/EU
- Electromagnetic compatibility (EMC) Directive, No.: 2014/30/EU

And inspected according to following

EU - Norms:

- EN 60 974-1:2012
- EN 60 974-10:2014+A1

Any alteration or change to these machines by any unauthorized person makes this Declaration invalid.

Wilkinson Star model
JM-500P

Jasic Model
MIG 500P (N368)

Authorised Representative

Wilkinson Star Limited
Shield Drive, Wardley Industrial Estate,
Worsley, Manchester M28 2WD
Tel 0161 793 8127

Signature

Dr John A Wilkinson OBE

Position Chairman

Manufacturer

Shenzhen Jasic Technology Co LTD
No3 Qinglan, 1st Road
Pingshan District
Shenzhen, China

Signature

Shenzhen Jasic Technology Co LTD

Position

Date



Company stamp

Date



Company stamp

STATEMENT OF WARRANTY

All new JASIC welders, plasma cutters and multi-process units sold through our partner Wilkinson Star Limited within the United Kingdom and Ireland shall be warranted to the original owner, non transferable, against failure due to defective materials or production. The warranty period is 5 years following the date of purchase. We recommend you register your product within 28 days of purchase. The original invoice is documentation for the standard warranty period. The warranty period is based on a single shift pattern.

Defective units shall be repaired or replaced by the company at our workshop. The company may opt to refund the purchase price (less any costs and depreciation due to use and wear). The company reserves the right to alter the warranty conditions at any time with effect for the future.

A prerequisite for the full warranty is that products are operated in accordance with the operating instructions supplied, observing the relevant installation and any legal requirements recommendations and guidelines and carrying out the maintenance instructions shown in the operator manual. This should be carried out by a suitably qualified competent person.

In the unlikely event of a problem, this should be reported to Jasic technical support team to review the claim.

The customer has no claim to loan or replacement products whilst repairs are being performed.

The following falls outside the scope of the warranty:

- Defects due to natural wear and tear
- Failure to observe the operating and maintenance instructions
- Connection to an incorrect or faulty mains supply
- Overloading during use
- Any modifications that are made to the product without the prior written consent
- Software errors due incorrect operation
- Any repairs that are carried out using non-approved spare parts
- Any transport or storage damage
- Direct or indirect damage as well as any loss of earnings are not covered under the warranty
- External damage such as fire or damage due to natural causes e.g. flooding

NOTE: Under the terms of the warranty, welding torches, their consumable parts, wire feed unit drive rolls and guide tubes, work return cables and clamps, electrode holders, connection and extension cables, mains and control leads, plugs, wheels, coolant etc. are covered with a 3 month warranty.

Jasic shall in no event be responsible for any third party expenses or expenses/costs or any indirect or consequential expenses/costs.

Jasic will submit an invoice for any repair work performed outside the scope of the warranty. A quotation for any non warranty will be raised prior to any repairs being carried out.

The decision about repair or replacement of the defective part(s) is made by Jasic. The replaced part(s) remain(s) Jasic property.

Warranty extends only to the machine, its accessories and parts contained inside. No other warranty is expressed or implied. No warranty is expressed or implied in regards to the fitness of the product for any particular application or use.

For further information on Jasic product warranty terms and product warranty registration please visit:

www.jasic-warranty.co.uk/terms

www.jasic-warranty.co.uk

WIRING DIAGRAM

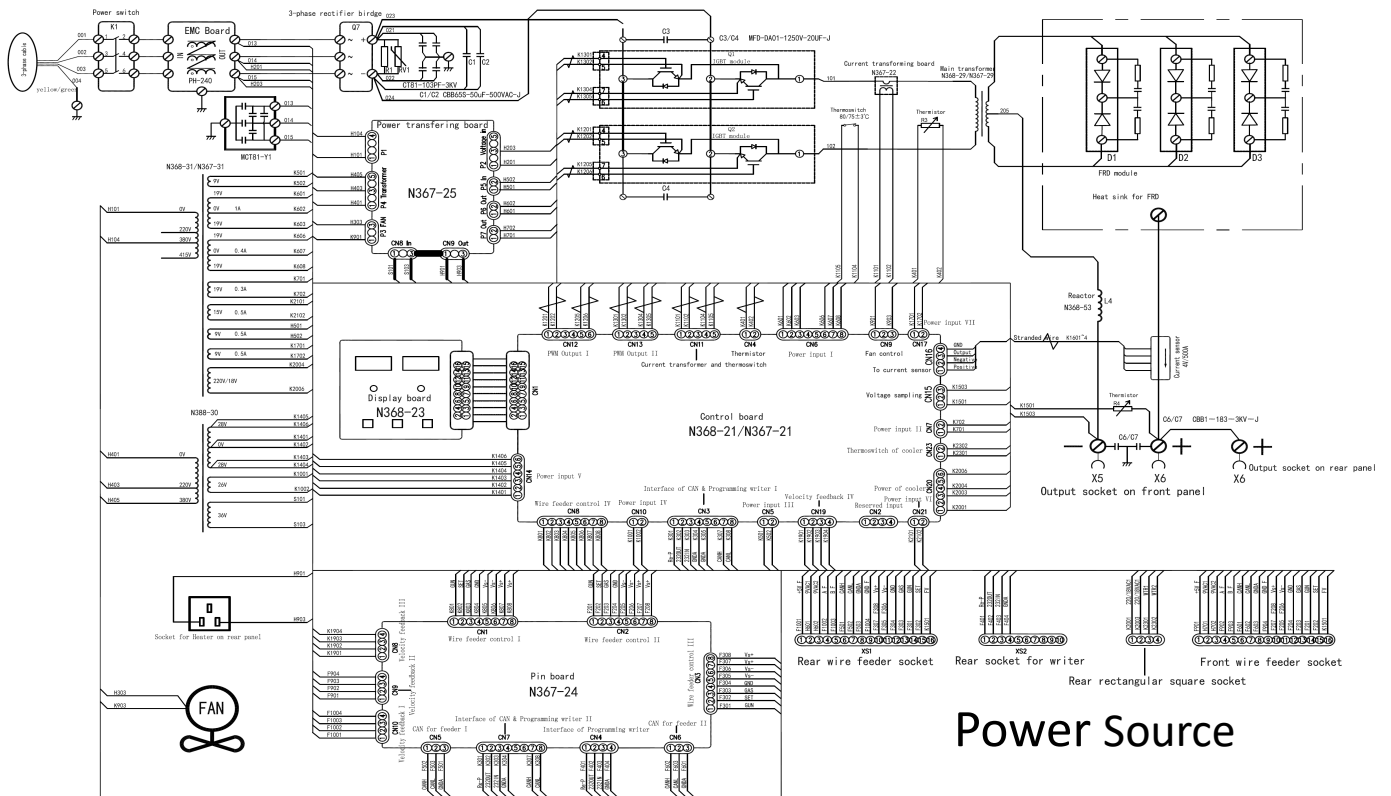

Power Source

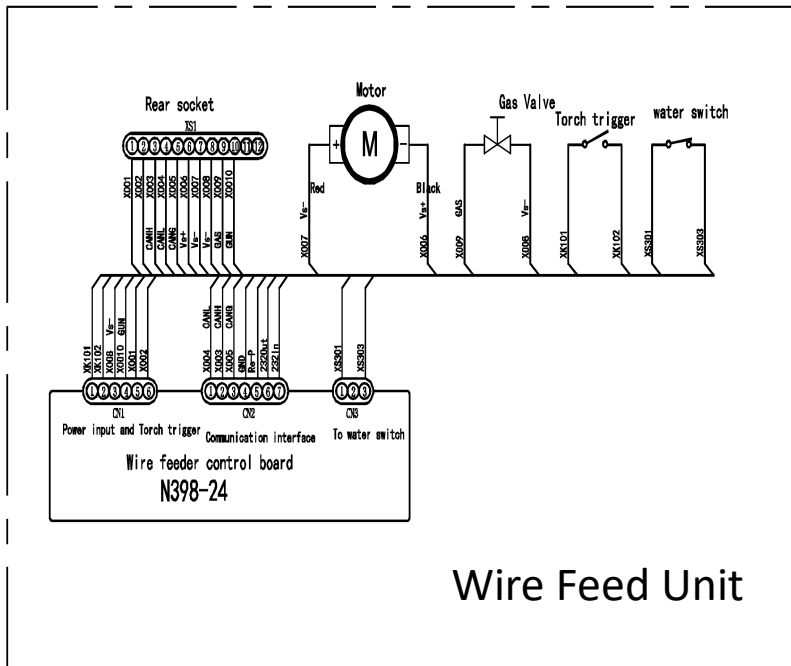

Wire Feed Unit

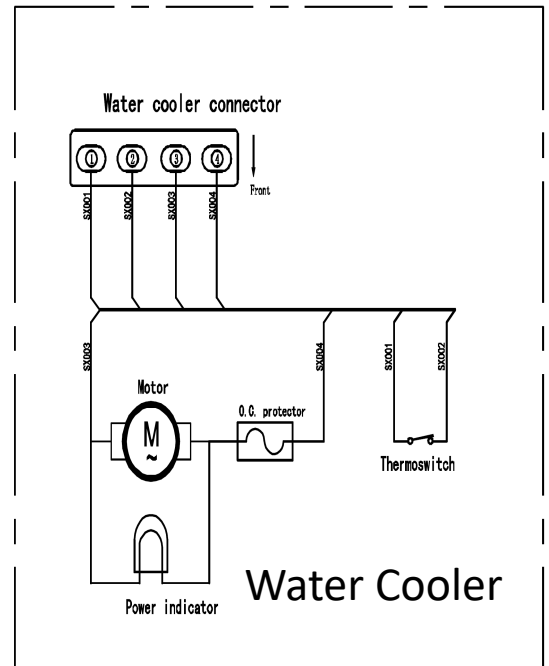

Water Cooler

OPTIONS AND ACCESSORIES

Part Number	Description
- - - -	MIG torch options for water cooled packages
T501-3	Titanium 501 MIG Torch Water Cooled 3mtr Euro
T501-4	Titanium 501 MIG Torch Water Cooled 4mtr Euro
T501-5	Titanium 501 MIG Torch Water Cooled 5mtr Euro
HC550-3E	Hard Core 550A MIG Torch Water Cooled 3m Euro
HC550-4E	Hard Core 550A MIG Torch Water Cooled 4m Euro
HC550-5E	Hard Core 550A MIG Torch Water Cooled 5m Euro
WCS50-5	Welding Cable Set 50mm (MMA) 5m
WCS70-5	Welding Cable Set 70mm (MMA) 5m
WC-5-05	Electrode Holder and Lead 50mm 5m
WC-7-05	Electrode Holder and Lead 70mm 5m
EC-5-05	Work Return Lead 50mm and Clamp 5m
EC-7-05	Work Return Lead 70mm and Clamp 5m
CP3550	Cable Plug 35-50mm
CP5070	Cable Plug 50-70mm
JH-HDX	Jasic HD True Colour Auto Darkening Welding Helmet
SSARG2G	Single Stage 2 Gauge Argon Regulator
JM-WF500P-5	5M Interconnecting Cable - Air/Water Cooled
JM-WF500P-10	10M Interconnecting Cable - Air/Water Cooled
JM-WF500P-20	20M Interconnecting Cable - Air/Water Cooled



MMA Lead Set



Jasic Auto Darkening HD Welding Helmet with True Colour Technology JH-HDX

DRIVE ROLL OPTIONS

Model	Feed Roll Part Number	Description	Quantity Required
JM-500P	10054932	"V" Groove 1.0mm/1.2mm	2
	10054935	"V" Groove 1.2mm/1.6mm	2
	10054937	Flat Pressure Roll	2
	1004V0608	"V" Groove 0.6mm/0.8mm	2
	10054934	"V" Groove 0.8mm/1.0mm	2
	10062293	Knurled 1.0mm/1.2mm	2
	10062292	Knurled 1.2mm/1.6mm	2
	10054933	V Pressure Roll 1.2mm/1.6mm	2
	10054936	V Pressure Roll 1.00mm/1.2mm	2
	10054931	"U" Groove 1.2mm/1.6mm	2
	10054930	"U" Groove 1.0mm/1.2mm	2

Wilkinson Star Limited

Shield Drive

Wardley Industrial Estate

Worsley

Manchester

UK

M28 2WD

+44 (0)161 793 8127



www.jasic.co.uk

January 2025 Issue 8